



**Geo Central Station &  
Solidcom H1 Wireless  
Intercom System**

**User Manual**

V1.0

## ■ Safety Instructions

For safety purposes, please read the following safety precautions before using the device to ensure proper product usage:

- Do not install the device near or inside heating appliances, cooking equipment, high-pressure containers (such as microwaves, induction cookers, electric ovens, electric heaters, pressure cookers, water heaters, gas stoves, etc.) to prevent battery overheating and explosion.
- Use only original manufacturer-certified chargers, cables, and batteries. Unauthorized or incompatible accessories may cause electric shock, fire, explosion, or other hazards.
- Prevent the power cord from being stepped on or squeezed, especially at the plugs, sockets, and extended sections.
- Disconnect the power plug during thunderstorms or when the device is not in use for extended periods.
- Do not disassemble the device unless directed by qualified manufacturer technicians.



## Preface

To ensure the safety of both the equipment and the operator, and to enhance system immunity against interference, the device must be properly grounded before operation. Use an electrical-grade conductor (recommended: stranded copper wire with a cross-sectional area of at least 2.5 mm<sup>2</sup>) and connect it securely to the protective earth (PE) or the system's common chassis ground.

The grounding connection should be low-impedance and as short as possible, avoiding shared paths with audio or data signal grounds to minimize ground-loop noise and electromagnetic interference.

### Caution:

Failure to provide proper grounding may result in equipment malfunction, audible noise interference, or damage caused by electrostatic discharge (ESD) or lightning events, posing potential safety hazards.

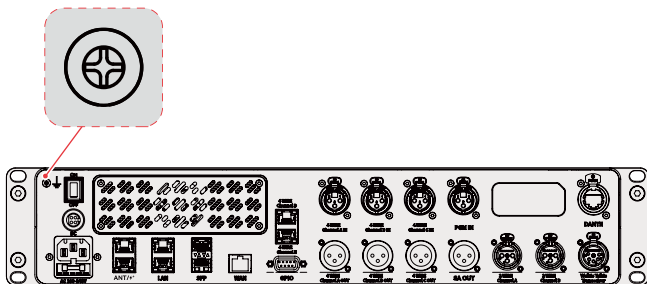

### Key Features

- The central station and antenna module feature a modular design. The central station supports cascading up to 8 antennas, while each antenna can operate independently without the central station. In standalone mode, antennas allow cascading of up to 3 units. Each antenna accommodates connections with 20 belpacks, enabling flexible network configurations to achieve full-duplex communication for 10–80 belpacks.
- The antenna delivers a 500-meter wireless coverage radius, with 8 antennas cascaded covering an area larger than 560 football fields. Seamless roaming cascade between antennas ensures uninterrupted connectivity, allowing belpacks to move freely within the coverage zone without signal dropout.
- The belpack features four dedicated call buttons and one reply button. Each call button supports binding with up to 4 audio channels. A single belpack can support full-duplex communication with up to 16 audio sources simultaneously.
- The system supports storage of up to 100 group configurations, 100 role presets, and 80 belpack profiles, enabling customized communication logic for diverse client scenarios while eliminating repetitive system configuration tasks.
- Ultra-compact belpack (net weight: 305) with integrated Bluetooth 5.2 module. Compatible with mainstream wireless headsets, enabling cable-free operation on set.
- Auto-Cascade enables plug-and-play connectivity between Geo Central Station and Solidcom ANT01 Antenna via Ethernet, requiring zero IP configuration or manual network parameter setup.
- The belpack supports quick pairing via the charging base. By connecting the base to the central station or antenna network, belpacks in the charging base can auto-pair and receive system configurations with one click — greatly improving setup efficiency for large-scale systems.
- The Geo Central Station/Solidcom ANT01 Antenna supports WiFi/Bluetooth connectivity with PCs and mobile devices. Wireless access via web configuration interface and Hollyvox APP enables remote adjustment of system parameters.

## ■ Key Features

- The system configuration document supports local import and upload, as well as cloud-based virtual configuration. This enables remote system configuration design, which can be saved locally for later on-site upload, significantly improving workflow efficiency.
- The Geo Central Station features a built-in 4×4 DANTE port, enabling direct integration of the intercom system into the on-site DANTE/AES67 network.
- The intercom system enables remote configuration access via web interface, allowing technical support personnel to provide real-time assistance over internet connections for on-site issue resolution.
- Systems equipped with the Geo Central Station support remote access for up to 8 cloud-based App users, while systems solely equipped with the Solidcom ANT01 still support remote access for up to 4 cloud-based App users. Real-time global access from any location is achievable via the internet.
- The beltpack system features replaceable batteries and includes a standard charging base capable of simultaneously charging 10 beltpacks or 10 individual batteries, with each battery providing over 15 hours of continuous operation.
- The professional intercom headset features a 0B10 interface, combining rugged durability with ergonomic comfort. Equipped with Dual-Mic ENC (Environmental Noise Cancellation), it delivers high-quality audio communication in noisy environments.

# Product Overview

## ■ Front Interface (Geo Central Station)

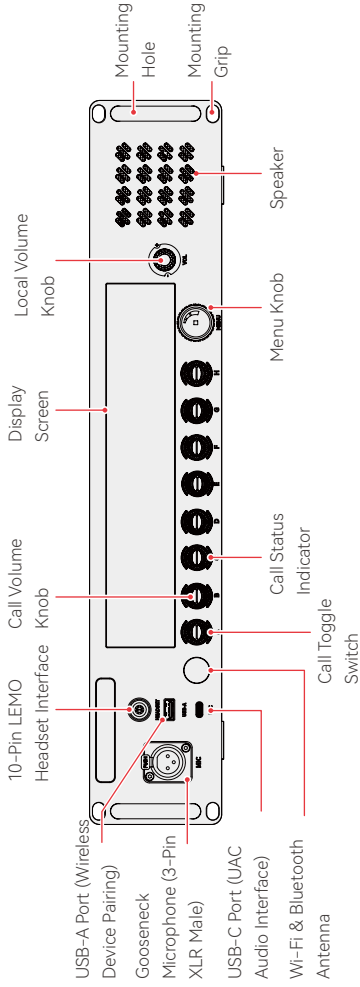

# Product Overview

## ■ Rear Interface (Geo Central Station)

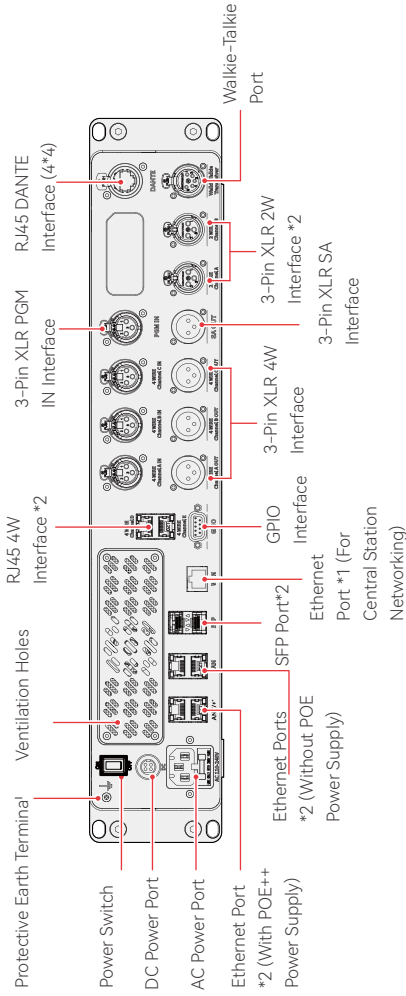

## LAN Interface

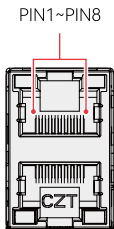

**LAN**

Standard Pinout			
PIN1	-POWER	PIN5	+POWER
PIN2	-POWER	PIN6	+POWER
PIN3	+POWER	PIN7	-POWER
PIN4	+POWER	PIN8	-POWER

## SFP Port

- Single-Mode Gigabit

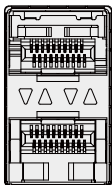

**SFP**

## GPIO Interface

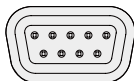

**GPIO**

Pin	Function
1	Ground (GND)
2	Relay 1 Normally Open (NO)
3	Relay 1 Normally Closed (NC)
4	Relay 1 Common (COM)
5	Relay 2 Normally Open (NO)
6	Relay 2 Normally Closed (NC)
7	Relay 2 Common (COM)
8	Input 1 (Optocoupler Isolated)
9	Input 2 (Optocoupler Isolated)

## 4-WIRE RJ45 Interface

- Input Impedance: 10K $\Omega$

### 4 WIRE Channel D

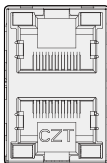

### 4 WIRE Channel E

Standard Pinout	
PIN1	GND
PIN2	GND
PIN3	AUDIO OUT+
PIN4	AUDIO IN+
PIN5	AUDIO IN-
PIN6	AUDIO OUT-
PIN7	GND
PIN8	GND

# Product Interfaces

## 4-WIRE XLR/PGM/SA Interface

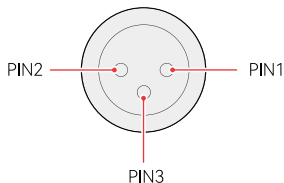

- PIN1: GND
- PIN2: AUDIO+
- PIN3: AUDIO-

## 2-WIRE Interface

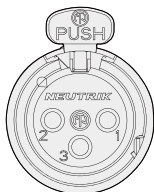

**2 WIRE  
Channel A**

- PIN1: GND
- PIN2: DC POWER / AUDIO
- PIN3: AUDIO

## LEMO Interface

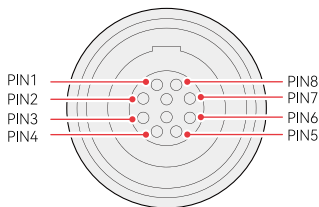

**HEADSET**

Standard Pinout			
PIN1	GND	PIN5	MICO
PIN2	DET	PIN6	MIC_GND
PIN3	GND	PIN7	MICP2
PIN4	SPK	PIN8	ENC_KEY

## MIC Interface

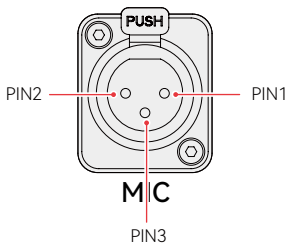

- PIN1: GND
- PIN2: AUDIO+(3V)
- PIN3: AUDIO-

# Product Overview

## Interface (Antenna)

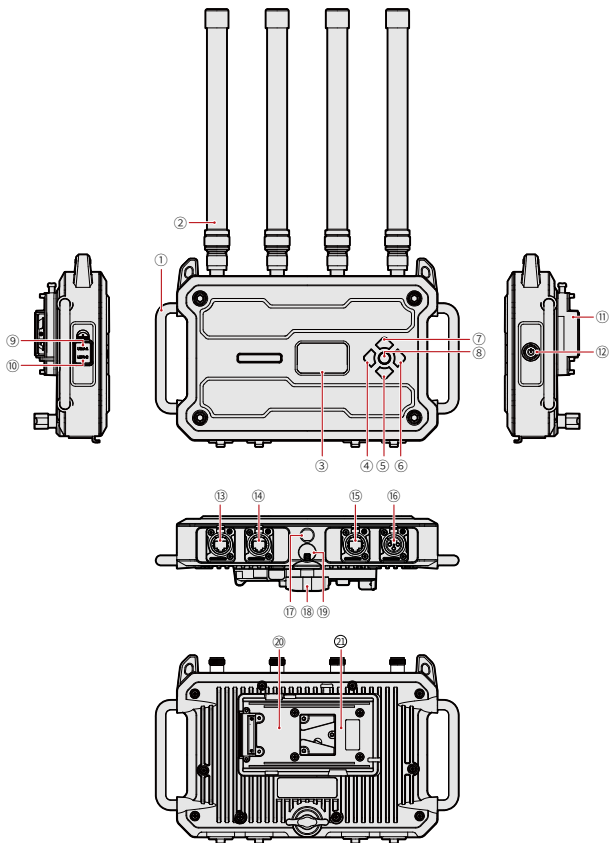

## ■ Interface (Antenna)

1. Handle
2. Fiberglass Antenna
3. Display Screen
4. Left Button
5. Down Button
6. Right Button
7. Up Button
8. Menu/Confirm Button
9. USB-A Port (for device pairing/upgrade)
10. USB-C Port (for UAC audio)
11. V/G-Mount Battery Plate
12. Power Switch (with LED indicator)
13. POE IN/LAN (RJ45)
14. POE OUT/LAN (RJ45)
15. 4-Wire Audio Interface (RJ45 with lock)
16. 2-Wire Audio Interface (3-Pin XLR F)
17. 3/8" Mount Hole
18. 5/8" Mount Hole
19. Quick-Release Knob
20. 3/8" Mount Hole\*2 (visible after battery plate removal)
21. Battery Connector Component (visible after battery plate removal)

## Interface (Antenna)

PoE IN&OUT Interface:

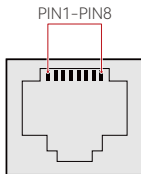

Standard Pinout			
PIN1	+POWER	PIN5	+POWER
PIN2	+POWER	PIN6	-POWER
PIN3	-POWER	PIN7	-POWER
PIN4	+POWER	PIN8	-POWER

2-Wire Audio Interface:

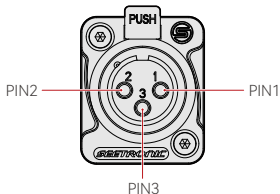

**RTS Single-Channel Mode**

PIN1: GND

PIN2: DC POWER/AUDIO

PIN3: /

**RTS Dual-Channel Mode**

PIN1: GND

PIN2: DC POWER/AUDIO 1

PIN3: AUDIO 2

**CLEARCOM**

PIN1: GND

PIN2: DC POWER

PIN3: AUDIO

4-Wire Audio Interface:

Input Impedance: 10K $\Omega$

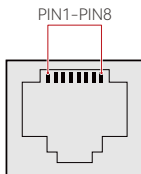

Standard Pinout			
PIN1	GND	PIN5	AUDIO IN-
PIN2	GND	PIN6	AUDIO OUT-
PIN3	AUDIO OUT+	PIN7	GND
PIN4	AUDIO IN+	PIN8	GND

## Interfaces (Belt Pack)

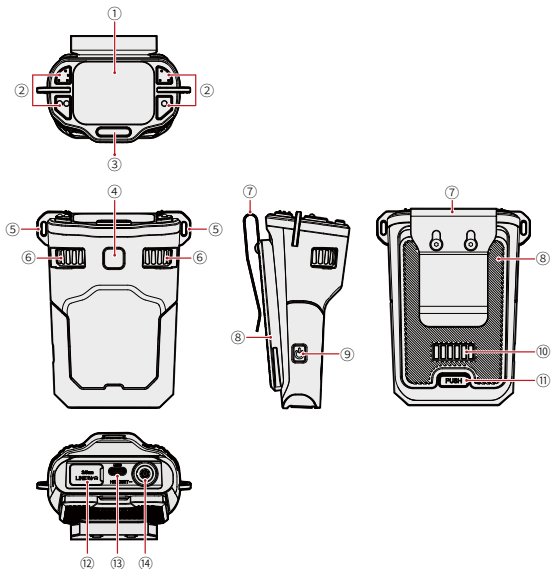

1. Display Screen
2. Call Buttons (A/B/C/D)
3. Reply Button (for call response)
4. Menu Button
5. Metal Component (lanyard eyelet / impact-resistant design)
6. Volume Knob
7. Metal Clip
8. Removable Battery
9. Power Switch
10. Charging Contacts (6-pin)
11. Battery Eject Button
12. 3.5mm Port (LINE IN/headset)
13. USB-C Port (for charging/device pairing/upgrade)
14. 10-Pin LEMO Interface (for headset/ accessories connection)

## Interfaces (Belt Pack)

### 10-Pin LEMO Interface

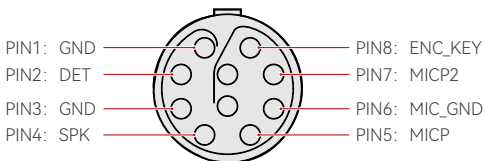

### 3.5mm Jack

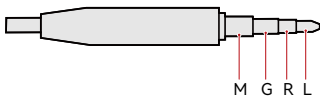

Interface Definition: M G R L

Microphone Capsule Impedance: 600 $\Omega$

Speaker Impedance: 32 $\Omega$

## Interfaces (Charging Base)

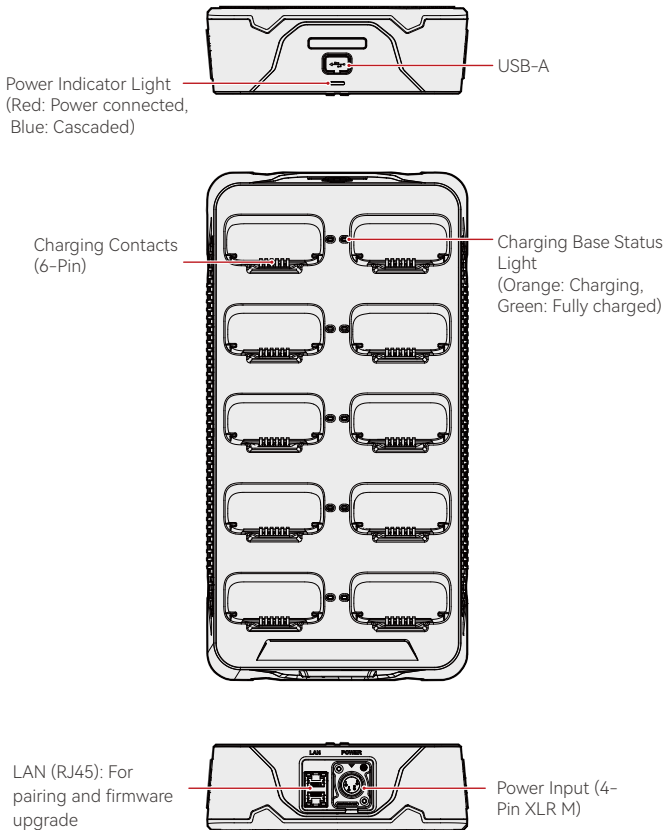

## ■ Interfaces (Charging Base)

Power Input:

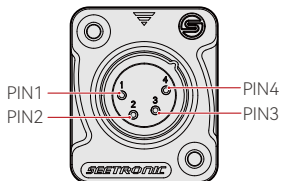

PIN1:GND  
PIN2:GND  
PIN3:VCC  
PIN4:VCC



## Antenna

1. Install the antennas as shown in the diagram.

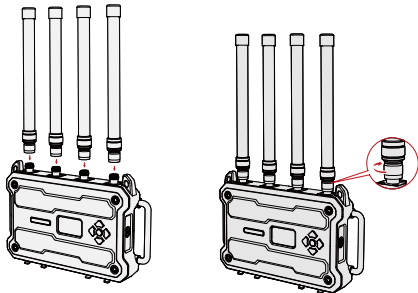

2. Mount the device on the tripod and secure it.

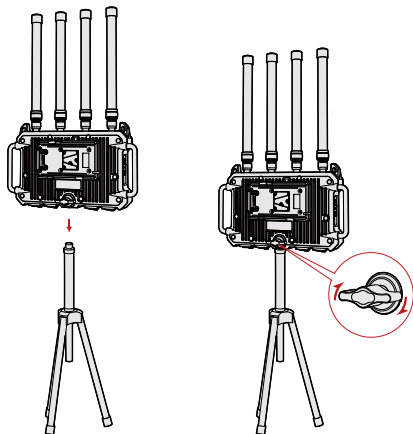

# Installation

## ■ Charging Base

The charging base features an M5 threaded hole at the bottom, allowing it to be secured to a standard 19-inch rack tray. The tray is wide enough to accommodate two charging bases side by side.

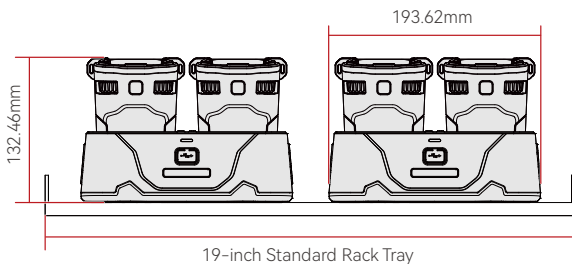
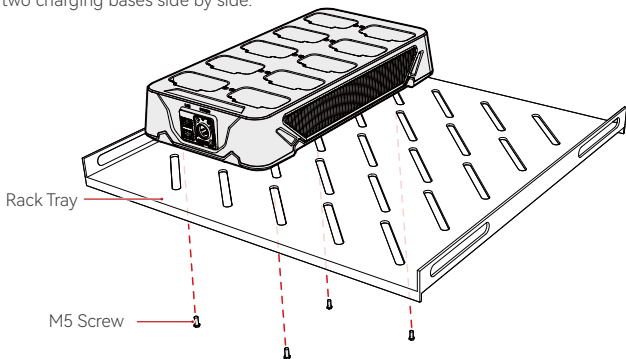

## Integrated Mode

A single central station supports cascading up to 8 antennas. Antennas can be daisy-chained via POE-powered network ports on the rear of the central station, with each POE port supporting up to 3 antennas.

Alternatively, antennas can be powered separately via an adapter and connected to the standard network ports on the central station.

In this mode, up to 80 beltpacks can be simultaneously online with full-duplex communication.

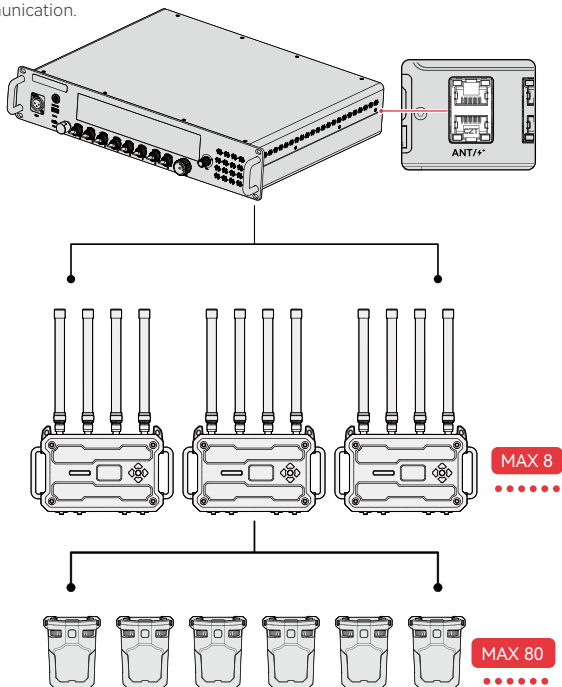

## Connection

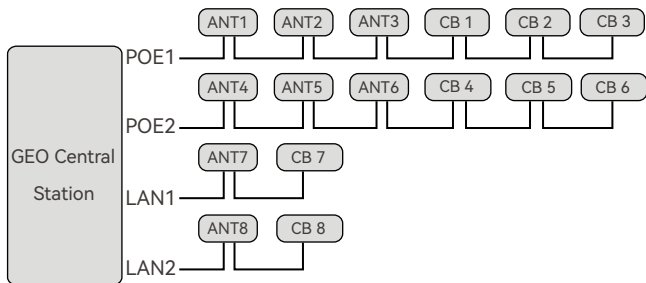

Note:

- Ports LAN1 and LAN2 do not support PoE function. Remote Stations 7 and 8 must be powered by an adapter.
- This is the recommended deployment method. For other requirements, please contact technical support personnel.

## Standalone Mode

### Multi-RRU cascading system

1. Standalone operation
  - Max 3 cascaded antennas without central station
  - Each antenna provides POE-powered LAN ports (1 set per unit)
2. Power distribution
  - Single POE adapter drives 3 antennas
3. System capacity
  - Supports concurrent beltpacks
  - Guarantees full-duplex communication

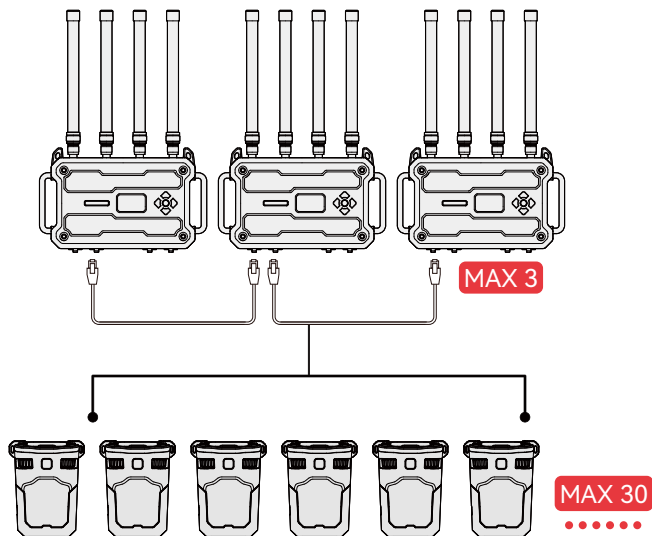

## Standalone Mode

### Single-RRU operation

#### 1. Capacity

- Supports 20 concurrent beltpacks
- Full-duplex communication

#### 2. Power configurations

- Power can be supplied via a POE adapter or a V/G mount battery. Please note that when using battery power, the official battery mounting plate must be installed on the back of the antenna.

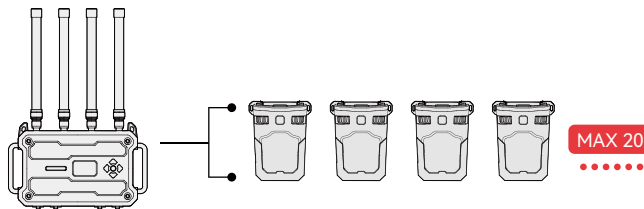

### Standalone

#### POE Adapter



#### Notes:

1. The distance between the PoE adapter and the RRU 1 must not exceed 10 meters.
2. The charging base must be powered by a DC adapter.
3. The recommended deployment setup is shown above. For alternative configurations or special requirements, please contact technical support.

## Switch Connection Scenario

- The Geo Central Station can connect to the Solidcom ANT01 via a network switch.

### Notes:

1. It is recommended to use a switch that supports AES67 or IEEE 1588. In the settings of the Geo Central Station or the Solidcom ANT01, select ptpy2 end-to-end as the synchronization mode. For detailed steps, refer to "Switch Synchronization Mode Configuration" in this document.
2. Ensure that DHCP is enabled on the Geo Central Station. In this case, the switch's DHCP service will automatically assign IP addresses to the devices.

### Recommended Wiring Diagram:

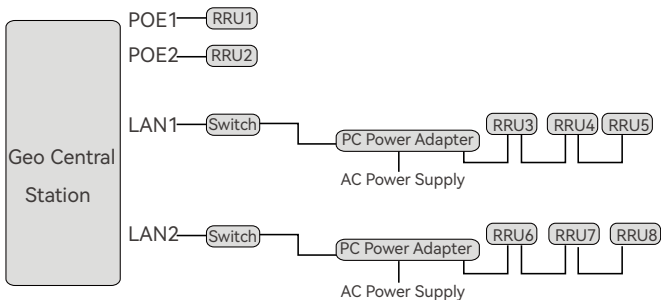

## ■ Pairing via Charging Base

This device supports automatic pairing with the antenna via the charging base. Follow the steps below:

1. Ensure both the antenna and the charging base are powered on and functioning properly. Use a standard RJ45 Ethernet cable to connect the antenna to the charging base. Once successfully cascaded, the indicator on the front of the charging base will turn solid blue.

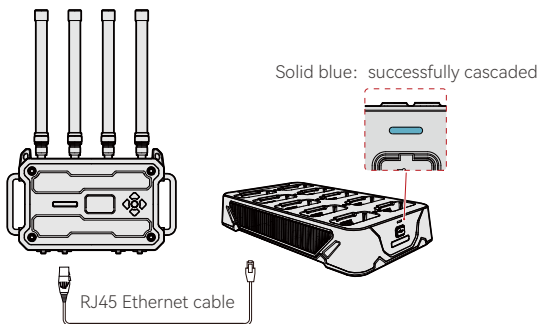

2. Insert the beltpack vertically into any slot of the cascaded charging base. After approximately 3 seconds, the beltpack will automatically pair with the current system.

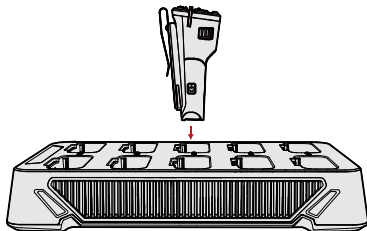

# Device Pairing

## Wired Pairing

This device supports wired pairing between the central station (or antenna) and the backpack. Follow the steps below:

1. Connect the central station or antenna to the backpack using a USB-A to USB-C cable.

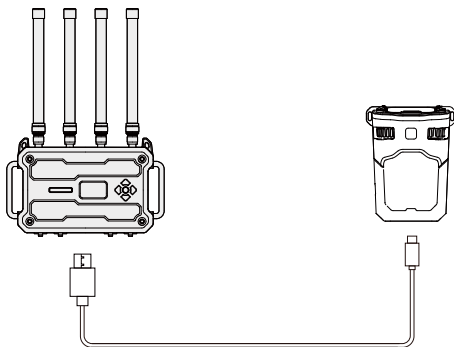
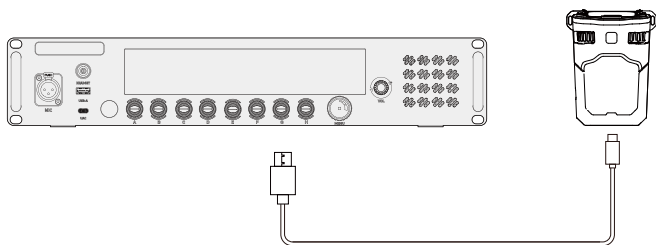

## Device Pairing

2. Wait for approximately 3 seconds until a pairing confirmation appears on the beltpack screen. Once displayed, you can unplug the cable — pairing is complete.

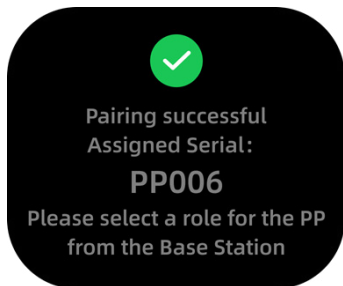

**Note:**

When the current group configuration is set to All in One Group, pairing a beltpack or headset will result in one of the following:

- a. If the role list is empty, the paired device will be automatically assigned to the All in One Group.
- b. If the role list is not empty, a role selection window will pop up. You can manually assign a role to the newly paired device.

By default, "Do not select for now" will be selected.

# Settings & Configuration

## Geo Central Station

- Screen 1

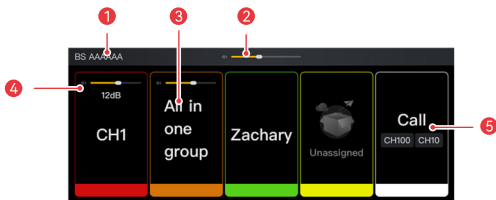

- ① Custom name for central station
- ② Speaker output adjustment (press to toggle mic input mode)
- ③ Knob-assigned communication source
- ④ Output gain adjustment for assigned source
- ⑤ Call function configuration (call target)

# Settings & Configuration

- Screen 2

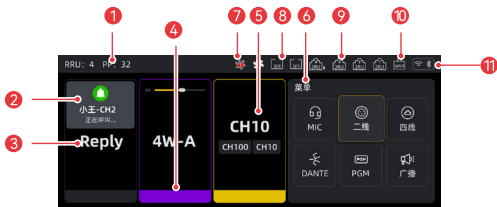

- ① Cascaded system status: Online RRUs / beltpacks
- ② Beltpack calling in
- ③ Knob assignment: Reply
- ④ Knob custom color
- ⑤ Combo configuration: Audio source + call target
- ⑥ System menu
- ⑦ Fan status: Solid white indicates normal operation, while the red indicates abnormal conditions. (In case of an abnormality, please restart the device or contact technical support.)
- ⑧ Optical port connection status: Optical Port 1 is multiplexed with LAN3, and Optical Port 2 is multiplexed with LAN4. The status is highlighted when connected and grayed out when disconnected.
- ⑨ LAN port connection status: LAN1 and LAN2 support PoE OUT. The connection status is highlighted when connected, along with the number of connected RRUs. The status is grayed out when disconnected.
- ⑩ WAN port network status: Highlighted when connected; grayed out when not connected.
- ⑪ Bluetooth & Wi-Fi dual-mode status: Indicates whether Bluetooth and Wi-Fi dual-mode is enabled or disabled.

# Wireless Network Settings

Select [Network] to access the central station's Bluetooth & Wi-Fi and wired network configuration menus.

**Note:**

Note: When configuring the network segment, avoid using the 68.x.x.x, 216.x.x.x, or 217.x.x.x subnets.

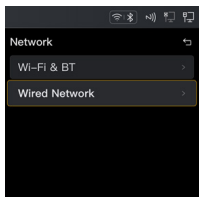

## Wi-Fi & Bluetooth Settings

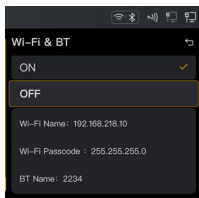

In this menu, you can toggle Wi-Fi and Bluetooth (enabled/disabled together), and view their names and the Wi-Fi password.

- When a computer is connected via Wi-Fi, you can access the web interface to view system status and configure settings.
- When a mobile device connects via Bluetooth, you can access the app to view system information and adjust parameters.
- When connected, you'll access the configuration of the entire cascaded system linked to this central station, allowing you to adjust settings for all connected devices.
- When configuring the network segment, avoid using the 68.x.x.x, 216.x.x.x, or 217.x.x.x subnets.

**Note:** One central station can be connected and controlled by only one Bluetooth device (e.g., a smartphone) at a time.

When the Geo Central Station is present, connect to the Wi-Fi or Bluetooth of Geo Central Station to control the entire intercom system.

# Wired Network Settings

## Wired Network

Click [Wired Network] to configure the LAN & SFP interfaces and the WAN interface of the central station.

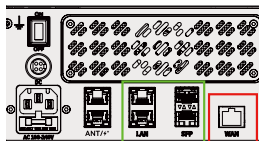
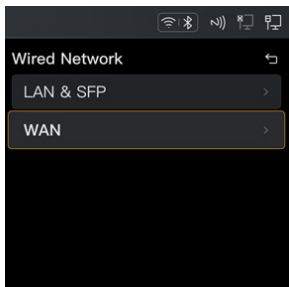

**Note:** The LAN ports and SFP ports are multiplexed in left-right pairs. If the upper LAN port is in use, the corresponding upper SFP port will be unavailable.

1. Click [LAN & SFP] to enter the local network configuration menu, where you can customize network parameters as needed.

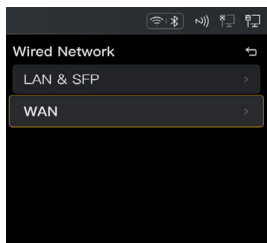

You can switch between Automatic IP (DHCP On) and Static IP (DHCP Off) modes. When using Static IP, you can manually configure the IP address, subnet mask, gateway, and DNS server.

The Web interface username and password are also viewable on this page.

## Settings & Configuration – Geo Central Station

- Click [WAN] to enter the wide area network configuration menu and customize network parameters as needed.

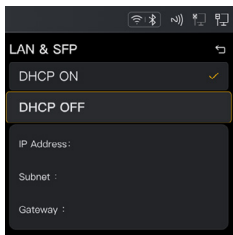

You can switch between Automatic IP (DHCP On) and Static IP (DHCP Off) modes. When using Static IP, you can manually configure the IP address, subnet mask, gateway, and DNS server.

The Web interface username and password are also viewable on this page.

**Note:** If DHCP is enabled but no DHCP service is detected within 30 seconds, a persistent pop-up will appear.

- Clicking Set Static IP will automatically switch to DHCP Off and return you to the configuration screen.
- Clicking Cancel will exit the DHCP detection process and return to the settings screen. Detection will only resume if DHCP is toggled again or the device is restarted.

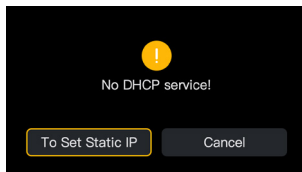

## ■ Group Settings

Select [Group] to access the group configuration menu. This interface allows quick setup for All in One Group Mode and viewing of current system group assignments. For more advanced group configurations, please use the web interface or Hollyvox app.

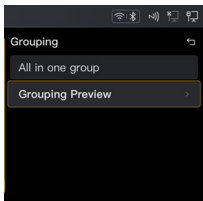

### 1. All in One Group (Default Mode)

Tap All in One Group to assign all communication-enabled devices in the current system — including the central station, beltacks, 4-wire, 2-wire, UAC, and wired interfaces — to the All in One Group channel.

## 2. Grouping Preview

Tap [Grouping Preview] to access the current system's group overview. This screen lists all existing groups. You can tap any group to view its associated devices.

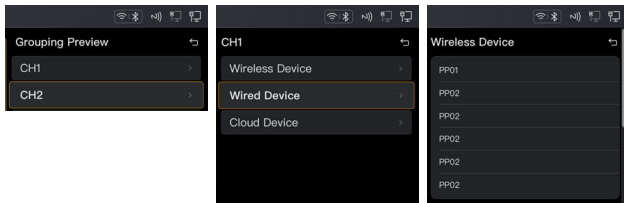

### ■ PP List

Tap [PP List] to enter the beltpack management menu. This menu allows you to view the status of all beltpacks in the current system and delete individual units if needed.

For advanced beltpack configuration, please use the web or Hollyvox App.

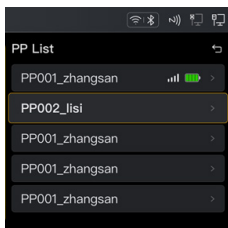

Select a beltpack to view its status, including real-time connection and assigned role.

You can also tap [Delete PP] to unpair it from the current system.

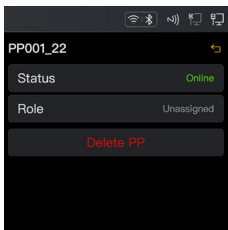

**Note:** Once unpaired, the beltpack will not automatically reconnect to the previous system after reboot. To resume use, it must be manually paired again.

## Display Settings

Select [Display] to enter the display configuration menu. By default, if no operation is performed for more than 5 seconds, the central station screen and button lights will automatically dim to standby brightness.

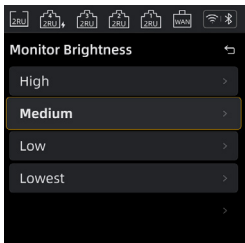

1. Monitor Brightness: Adjust the screen brightness and standby brightness with four levels: High, Medium, Low, and 1%.

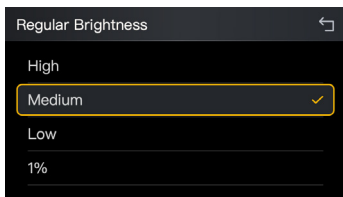

2. Button Brightness: Adjust the button brightness and standby brightness with four levels: High, Medium, Low, and 1%.



# Settings & Configuration – Geo Central Station

## Mic Settings

Select [Mic Settings] to adjust the gooseneck mic and wired headset mic settings on the central station.

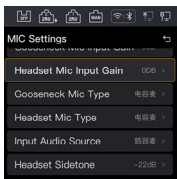

## Gooseneck Mic Input Gain

Tap [Gooseneck Mic Input Gain] to access the gain adjustment menu. Choose an appropriate gain level based on input volume.

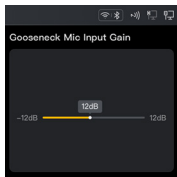

## Headset Mic Input Gain

Tap [Headset Mic Input Gain] to access the gain adjustment menu. Choose an appropriate gain level based on input volume.

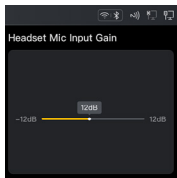

## Gooseneck Mic Type

Tap [Gooseneck Mic Type] to enter the selection menu and choose the type of gooseneck mic in use.

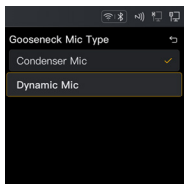

## Headset Mic Type

Tap [Headset Mic Type] to enter the selection menu and choose the type of headset mic in use.

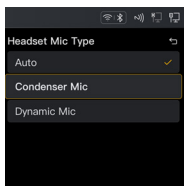

## Input Audio Source

Tap [Input Audio Source] to choose whether the gooseneck mic or headset mic will serve as the main microphone input for the central station.

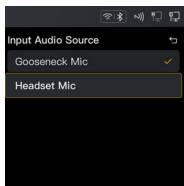

## 4-Wire Interface Settings

Select [4WIRE] to access the interface selection menu. Here, you can choose the 4-wire port you wish to configure.

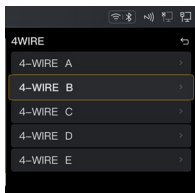

**Note:** Ports A,B,C use XLR connectors, while ports D, E use RJ45 connectors. Tap the desired interface to enter its configuration menu.

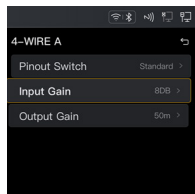

1. Input Gain: Tap [Input Gain] to open the input gain adjustment menu and set the appropriate level based on your input volume.

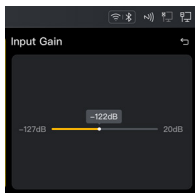

## Settings & Configuration - Geo Central Station

2. Output Gain: Tap [Output Gain] to open the output gain adjustment menu and set the appropriate level based on your output volume.

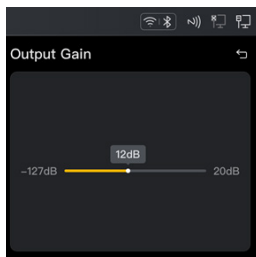

3. Pinout Switch: Tap [Pinout Switch] to access the wiring configuration menu. You can set the 4-wire interface to either Standard or Crossover based on your system requirements.

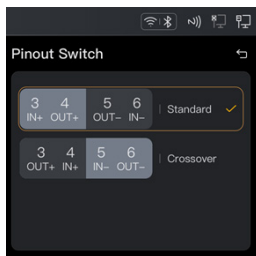

## PGM Input Settings

Tap [PGM Input Gain] to access the gain adjustment menu. Set the input gain based on the input signal level.

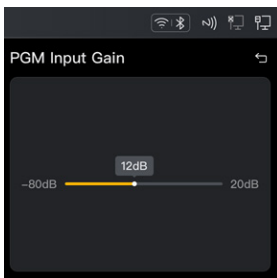

## SA Output Settings

Tap [SA Output Settings] to access the gain adjustment menu. Set the input gain according to input signal level.

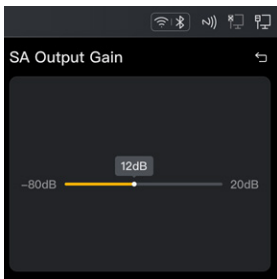

## 2-Wire Settings

Select [2Wire Mode] to enter the 2-wire interface selection menu, where you can choose the specific interface number you want to configure.

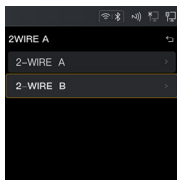

Select the desired interface to access its configuration menu.

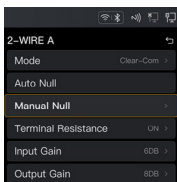

1. Mode Switching: Tap [Mode] to open the mode selection menu. Choose the appropriate mode based on the type of device connected to the 2-wire interface.

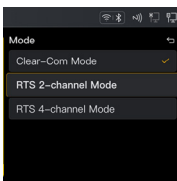

## Settings & Configuration – Geo Central Station

2. Auto Null: After connecting a 2-wire device, tap [Auto Null] for one-click calibration — no manual setup needed.

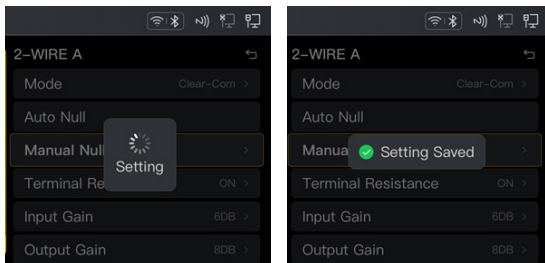

3. Manual Null: you can manually adjust parameters such as Cable Compensation, Termination Resistance, and Input/Output Gain to fine-tune the connection.
- a. Cable Compensation: Tap [Cable Compensation] to enter the adjustment menu and select a suitable compensation level based on your need.

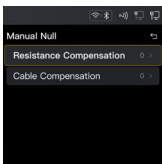

- b. Termination Resistance: Tap [Termination Resistance] to access the termination toggle menu, where you can enable or disable the termination resistor depending.

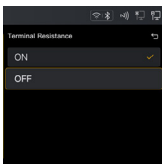

## Settings & Configuration – Geo Central Station

- c. Input Gain: Tap [Input Gain] to access the input gain adjustment menu and select a suitable gain level based on the input signal level.

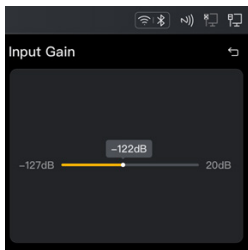

- d. Output Gain: Tap [Output Gain] to access the output gain adjustment menu and select a suitable gain level based on the output signal level.

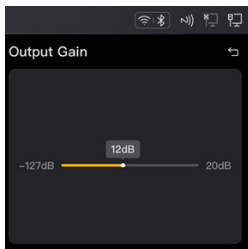

## Walkie-Talkie Settings

Select [Walkie-Talkie Settings] to enter the configuration menu.

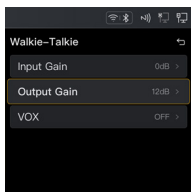

1. Input Gain: Tap [Input Gain] to access the input gain adjustment menu and select a suitable gain level based on the input signal level.

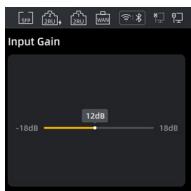

2. Output Gain: Tap [Output Gain] to access the output gain adjustment menu and select a suitable gain level based on the output signal level.

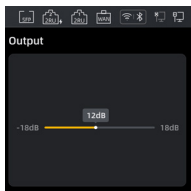

# Settings & Configuration - Geo Central Station

3. VOX Settings: Tap [VOX] to enable or disable VOX mode and adjust the VOX trigger sensitivity.

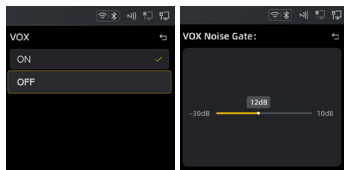

## DANTE Interface Settings

### DANTE Interface Settings

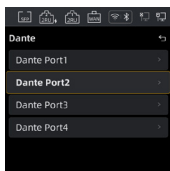

### GPIO Settings

GPIO configuration is performed on the Web interface. For details, refer to Web Configuration → GPIO Configuration in this document.

## System Settings

Tap [System] to view central station information, get device binding codes, and update firmware.

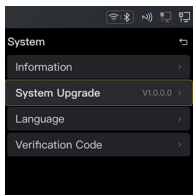

## Information

Tap [Information] to view all current main station details and admin account info.



## System Update

Tap [System Update] to check online for the latest available firmware.

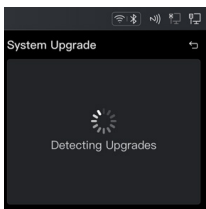

Based on the current system status, you may encounter the following cases:

- a. Device Not Connected to the Internet: Firmware check will fail if the device is offline or encounters network issues. Please resolve the issue based on the error code and retry.

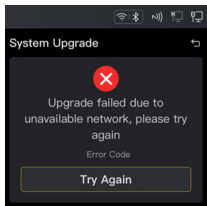

## Settings & Configuration – Geo Central Station

- b. No New Version Available: The current system firmware is up to date. No newer version is available.

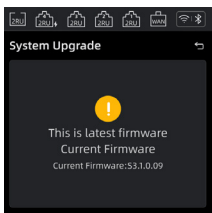

- c. New Version Detected: A newer firmware version is available. Please confirm and proceed with the upgrade manually.

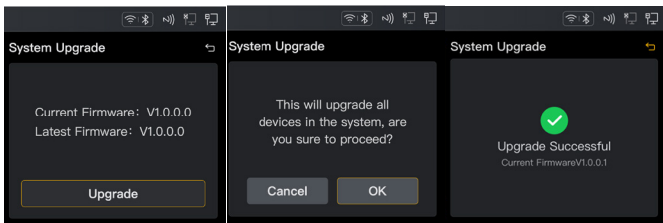

**Note:**

This operation will upgrade all eligible devices in the current cascade network. To upgrade individual devices only, disconnect the others before proceeding.

## Language

Tap [Language] to access the language settings menu and select your preferred system language.

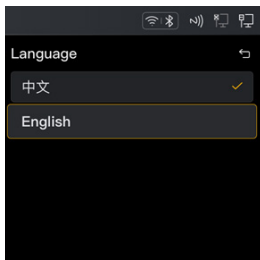

## Verification Code

Tap [Verification Code] to get the code.

Make sure the central station is connected to the internet. Once refreshed, the code can be entered in the mobile app to bind the device.

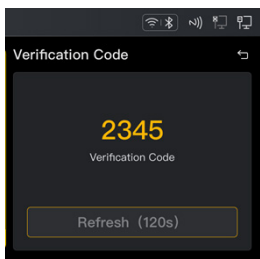

# Settings & Configuration – Solidcom ANT01

## Solidcom ANT01

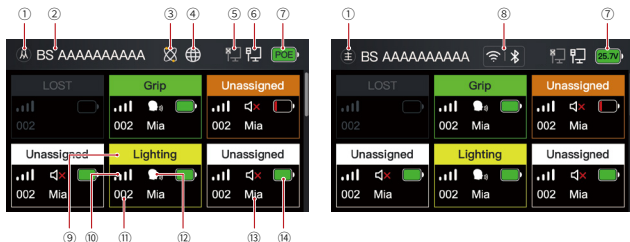

1. Master/Remote Identifier
2. Antenna Name
3. Roaming Status (visible: on, hidden: off)
4. Network Connection Status (visible: connected, hidden: disconnected)
5. Left Ethernet Port Status (white: connected, gray: disconnected)
6. Right Ethernet Port Status (white: connected, gray: disconnected)
7. Power Status: POE/power supply (voltage displayed)
8. Wi-Fi & Bluetooth Status (white: on, gray: off)
9. Beltpack Role
10. Beltpack Signal Strength
11. Beltpack ID
12. Beltpack Status: Talk/Mute
13. Beltpack Name (displays beltpack ID if unnamed)
14. Beltpack Battery Level

### Note:

- Each antenna can display information for up to 10 beltpacks.
- Use short presses of the Up/Down buttons to page through the list.

Disconnected beltpacks are not displayed in the list.

# Settings & Configuration – Solidcom ANT01

Press and hold the antenna [Menu/Confirm] button for 3 seconds to enter the menu.

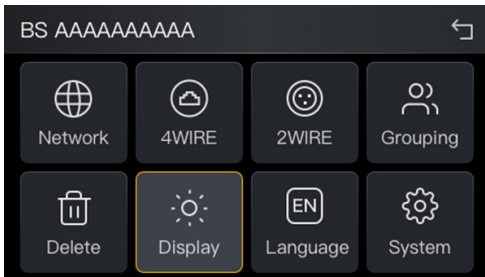

## Network Settings

Select [Network] to adjust DHCP and Wi-Fi & Bluetooth options.

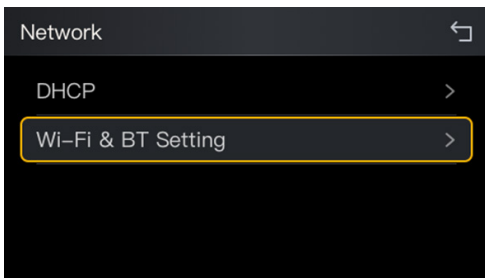

## DHCP Settings

Select [DHCP] to enter the network configuration menu. Here, you can switch between Dynamic IP (DHCP On) and Static IP (DHCP Off) modes.

In Static IP mode, you can modify the IP address, subnet mask, gateway, and DNS settings.

You can also view the web username and password on this page.

### Note:

When DHCP is enabled and the device is not connected to a router, the status will display "No Service."

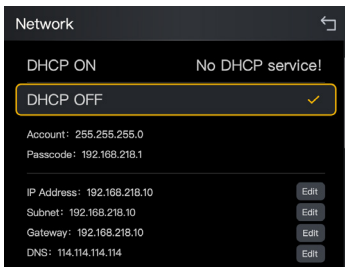

### Wi-Fi & Bluetooth Settings

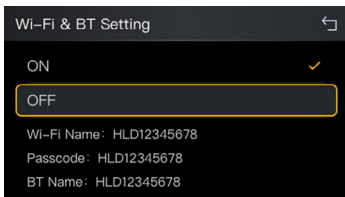

- Allows simultaneous toggling of Wi-Fi and Bluetooth.
- Displays Wi-Fi and Bluetooth names, and the Wi-Fi password.
- Wi-Fi Connection (PC): you can access the web interface via Wi-Fi to view system information and configure parameters.
- Bluetooth Connection (Mobile): Use the Hollyvox app to view system information and configure parameters through Bluetooth.
- When connected, you can manage the configuration parameters of all devices within the cascade system.

#### Note:

This operation will update all upgradeable devices in the current cascade network. To upgrade specific devices only, first disconnect other devices from the cascade connection.

## Group Settings

Tap [Grouping] to access the group configuration menu. This function is only available in Standalone Mode for quick group setup or switching to All in One Group.

For systems using Integrated Mode, group settings must be configured via the web or app interface.

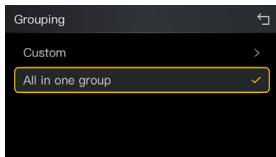

### 1. All in One Group

Tap [All in One Group] to assign all communicable devices in the current system — including the central station, beltpacks, headsets, 4-wire and 2-wire interfaces, UAC devices, and wired ports — to the All in One Group channel. In this group, the audio source is set to All in One Group, the communication rights are Talk & Force Listen, and no roles are assigned. All devices can communicate with each other.

The assigned button varies by beltpack/headset model.

### 2. Custom

Tap [Custom] to enter grouping Interfaces

The Solidcom ANT01 supports up to 100 groups and 100 roles, with each role including basic configurations such as button functions, audio settings, and brightness for beltpacks and headsets. These settings can be quickly applied via the antenna, web, or Hollyvox app.

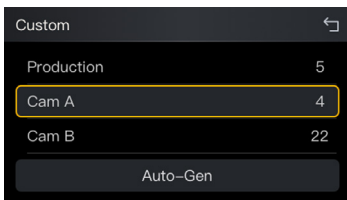

The custom page displays a list of roles preconfigured via the web or Hollyvox app, sorted from most recently to least recently modified.

Use the left and right arrows to adjust the number of devices assigned to each role as needed. Then, click Auto-Gen to save and push the configurations to the currently online beltpacks and those placed in charging bases (charging bases must be connected to the antenna).

Please note that configurations will be distributed based on the list order and assigned quantities, following the priority below:

- a. Beltpacks that are currently online
- b. Belt packs placed in charging bases.
- c. Devices that come online after A and B
- d. Devices placed into charging bases after A and B
- e. Devices that come online after C and D
- f. Devices placed into charging bases after C and D

If there are remaining configurations after assignment, the antenna will enter a standby state and continue monitoring until all assignments are completed.

Once the devices have been assigned, distribute them to the appropriate team members according to device ID or custom naming — then you're ready to start working.

### Delete Beltpack

Select [Delete PP] to enter the beltpack configuration menu.

This function is only available in Standalone Mode.

If the system is in Integrated Mode, please remove beltpacks via the web or mobile app.

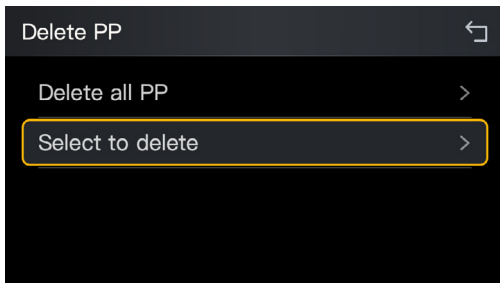

## Settings & Configuration – Solidcom ANT01

1. Click [Delete All PP] to remove all registered beltpacks and headsets from the antenna. Deleted devices must be re-paired before they can be used again.
2. Click [Select to Delete] to enter the registered devices list, where you can select multiple beltpacks or headsets to delete. Deleted devices will lose communication, while others remain unaffected.

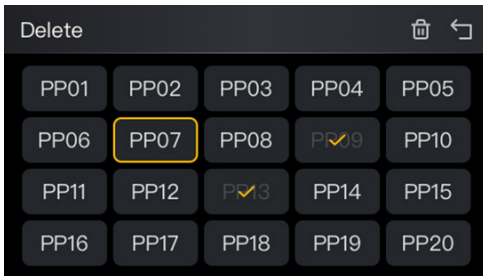

### 4-Wire Interface Settings

Select [4WIRE] to enter the 4-wire interface configuration menu.

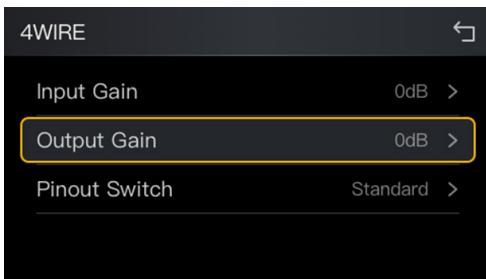

## Settings & Configuration – Solidcom ANT01

1. Input Gain: Click [Input Gain] to enter the input gain adjustment menu, where you can select the appropriate gain based on the input volume.

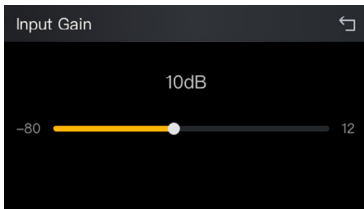

2. Output Gain: Click [Output Gain] to enter the output gain adjustment menu, where you can select the appropriate gain based on the output volume.

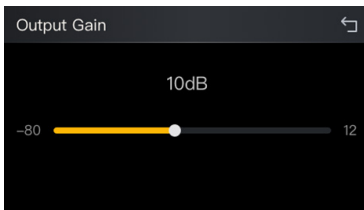

3. Pinout Switch: Click [Pinout Switch] to enter the wiring mode menu, where you can set the antenna's 4-wire interface to either Standard Mode or Crossover Mode as needed.

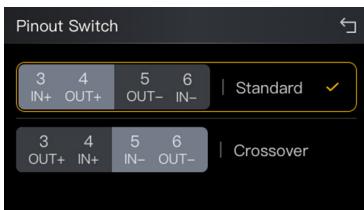

## 2-Wire Interface Settings

Select [2WIRE] to enter the 2-wire interface configuration menu.

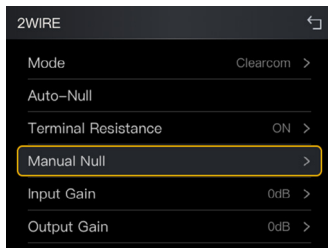

1. Mode Switch: Click [Mode] to enter the mode menu and select the appropriate mode based on the connected 2-wire device.

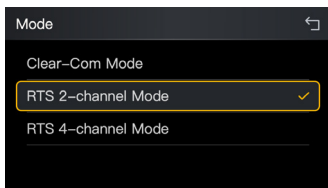

2. Auto Null: After connecting a 2-wire device, click [Auto Null] to automatically calibrate the device without manual parameter adjustments.
3. Manual Null: Click [Manual Zero Calibration] to enter the manual calibration menu and adjust each parameter individually.

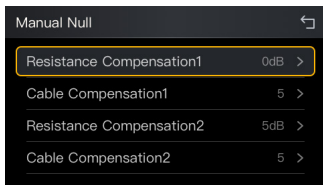

## Settings & Configuration – Solidcom ANT01

- a. Cable Compensation: Click [Cable Compensation] to enter the input compensation menu, where you can select the appropriate cable compensation based on the scenario.

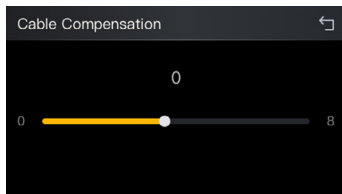

- b. Terminal Resistance: Click [Terminal Resistance] to enter the input resistor toggle menu, allowing you to enable or disable terminal resistance as needed.

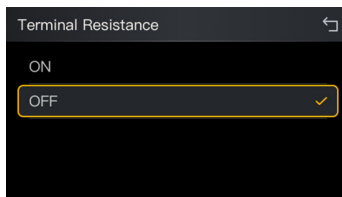

- c. Resistance Compensation: Click [Resistance Compensation] to enter the input compensation menu, where you can select the appropriate resistance compensation based on the scenario.

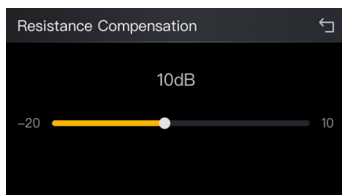

## Settings & Configuration – Solidcom ANT01

- d. Input Gain: Click [Input Gain] to enter the input gain adjustment menu and select the appropriate gain based on input volume.

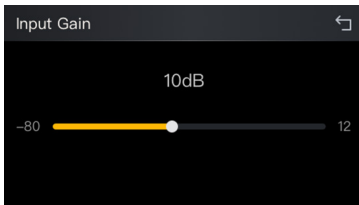

- e. Output Gain: Click [Output Gain] to enter the output gain adjustment menu and select the appropriate gain based on output volume.

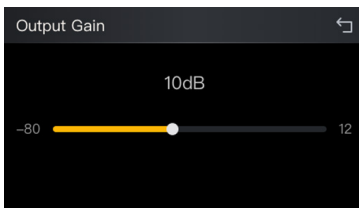

### ■ Display Settings

Select [Display] to enter the display settings menu. By default, if there is no operation for more than 5 seconds, the antenna screen will automatically switch to standby brightness.

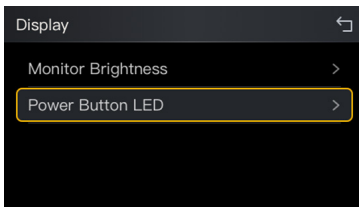

## Settings & Configuration – Solidcom ANT01

Select [Monitor Brightness] to enter the interface for adjusting default and standby screen brightness.

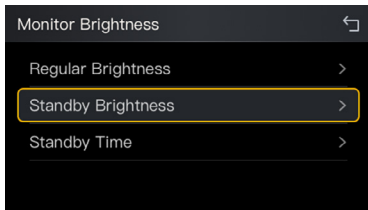

1. Click [Regular Brightness] to adjust the screen brightness with 4 levels: High, Medium, Low, and 1%.

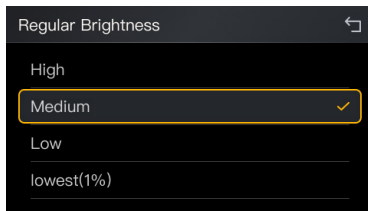

2. Select [Standby Brightness] to adjust the standby brightness with 4 levels: High, Medium, Low, and Off.

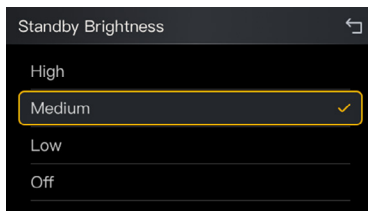

## Settings & Configuration – Solidcom ANT01

3. Select [Standby Time] to adjust the standby time with 4 options: 30 seconds, 1 minute, 2 minutes, and 5 minutes.

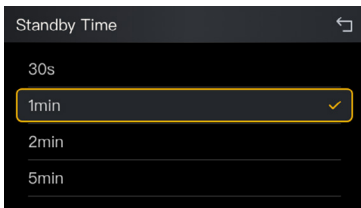

- Select [Power Indicator Light Settings] to control the on/off status of the indicator light on the power button.

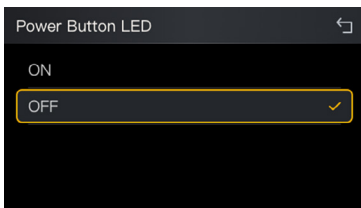

### Language Settings

- Select [Language] to enter the language settings menu, where you can choose the system language as needed.

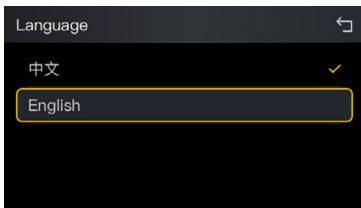

## System Settings

Select [System] to enter the hub information menu. In this interface, you can view antenna details, obtain verification codes, restore factory settings, and update the firmware.

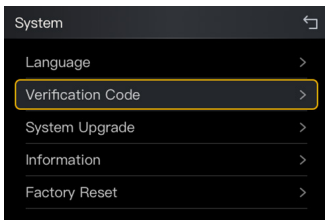

### Verification Code

Tap [Verification Code] to get the code.

Make sure the antenna is connected to the internet. Once refreshed, the code can be entered in the mobile app to bind the device.

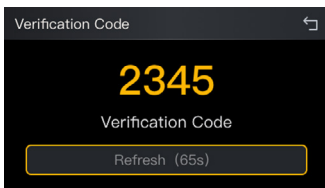

### System Update

Tap [System Update] to check online for the latest available firmware.

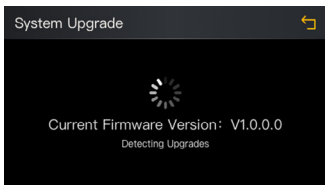

## Settings & Configuration – Solidcom ANT01

Based on the current system status, you may encounter the following cases:

- a. Device Not Connected to the Internet: Firmware check will fail if the device is offline or encounters network issues. Please resolve the issue based on the error code and retry.

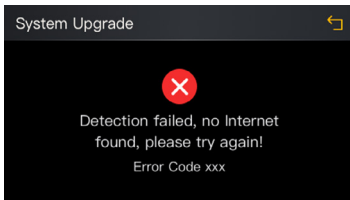

- b. No New Version Available: The current system firmware is up to date. No newer version is available.

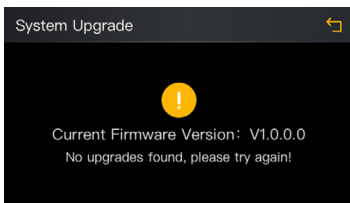

- c. New Version Detected: A newer firmware version is available. Please confirm and proceed with the upgrade manually.

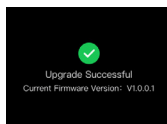
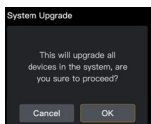
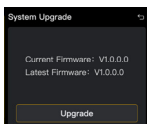

### Note:

This operation will upgrade all eligible devices in the current cascade network. To upgrade individual devices only, disconnect the others before proceeding.

## Settings & Configuration - Solidcom ANT01

### Information

Select [Information] to view all current antenna details and administrator account information.

Information		
BS ID:	123456	
Name:	BS-导演组	
SN	123456789	
Hardware Version:	V1.0.0.0	
Firmware Version:	H000	

# Settings & Configuration - Solidcom BPK01

## Solidcom BPK01

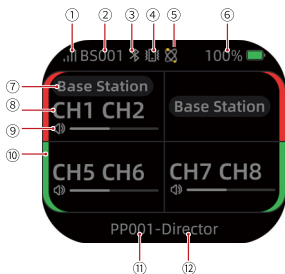

1.Signal Strength

2. Connected Antenna Name

3. Bluetooth Status (white: on, gray: off)

4. Vibration Status (white: on, gray: off)

5. Roaming Icon: The icon is displayed when the roaming switch is turned on.

6. Battery Level

7. Call Target

8.Communication Target

9.Output Gain for Communication Target

10.Talk Permission for Communication Target

11.Beltpack Name (displays beltpack ID if unnamed)

12.Assigned Role Group of Beltpack

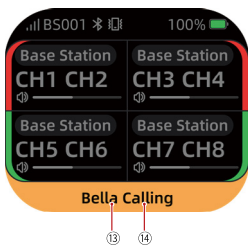

13.Incoming Caller Name

14.Channel Used by Caller

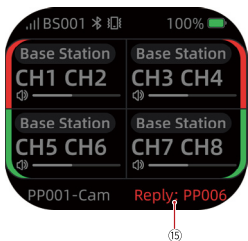

15.Missed/Unanswered Caller

### Menu

Long press the beltpack's [Menu] button for 3 seconds to enter the menu.

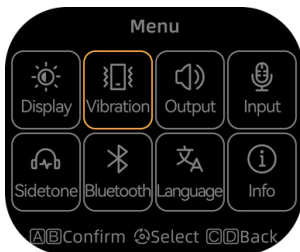

In any interface, press and hold the beltpack's [Menu] button for 5 seconds to enter flashlight mode. In this mode, the indicator light on the [Reply] button located on the side of the beltpack screen will illuminate.

Press and hold the [Menu] button for 5 seconds again to exit flashlight mode.

## ■ Display Settings

Select [Display] to enter the menu. By default, if there is no operation for more than 5 seconds, the screen and buttons will dim to standby brightness.



1. Select [Monitor Brightness] to adjust both screen and standby brightness. Four levels are available: High, Medium, Low, and Lowest (1%).



2. Select [Button Brightness] to adjust both button and standby brightness. Four levels are available: High, Normal, Low, and Off.



## Vibration Settings

Select [Vibration] to enter the menu. You can enable or disable beltpack vibration as needed.



## Output Gain

Select [Speaker] to enter the output gain settings menu. Here, you can adjust the output gain for all audio outputs, including the LEMO port, 3.5mm jack, and Bluetooth.

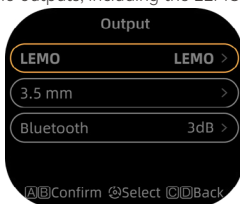

1. LEMO: Adjust output gain when using a LEMO-connected device (e.g., LEMO headset).
2. 3.5mm: Adjust output gain when using a 3.5mm-connected device (e.g., 3.5mm headset).



- Bluetooth: Adjust output gain when using a Bluetooth-connected audio device (e.g., wireless Bluetooth headset).

### ■ Input Gain

#### Microphone Gain

Select [Microphone] to enter the belt pack input gain settings interface. In this menu, users can adjust the input gain for all audio input sources on the belt pack as needed, including the LEMO input gain, 3.5mm input gain, and Bluetooth input gain.

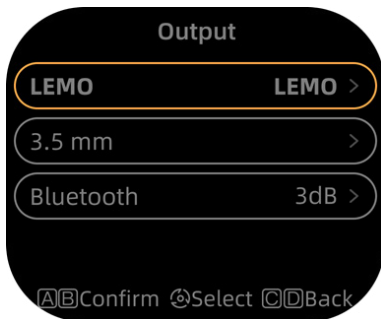

- LEMO: Adjust input gain for devices connected via the LEMO port (e.g., LEMO headset).
- 3.5mm: Adjust the input gain based on the type of device connected via the 3.5mm port:
  - Headset: Adjust microphone input gain
  - Camera/Phone (MIC IN): Adjust input gain for audio from monitoring or output ports
  - Mixer (LINE IN): Adjust input gain for audio from the mixer's LINE OUT port
- Bluetooth: Adjust input gain for devices connected via Bluetooth (e.g., wireless headset).

## Sidetone

Select [Sidetone] to enter the sidetone gain settings menu. Here, you can adjust the sidetone level or turn it off as needed.



## Bluetooth

Select [Bluetooth] to enter the beltpack's Bluetooth settings menu. Here, you can enable or disable Bluetooth, and pair or disconnect wireless Bluetooth devices as needed.

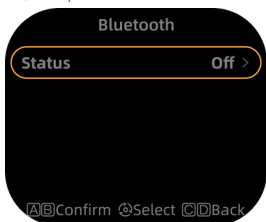

### 1. Bluetooth Switch:

Enable to connect with Bluetooth devices; disable to disconnect and block pairing.

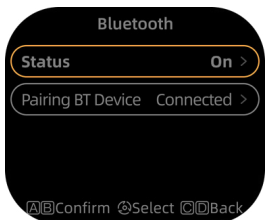

## 2. Pairing

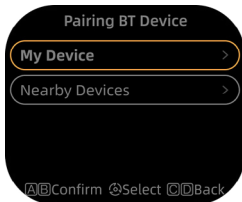

a. My Devices: Displays currently or previously connected devices. Tap a device to disconnect or delete it.

**Note:**

Each beltpack can remember only one device. Pairing a new device will replace the previous one.

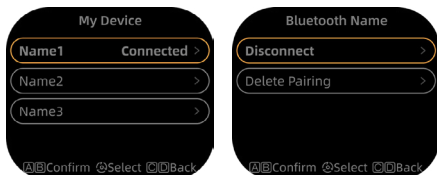

b. Nearby Devices: Shows available Bluetooth devices nearby. Tap a device to pair and connect.

**Note:**

A maximum of 20 nearby devices will be displayed. If your device does not appear, try restarting Bluetooth or repositioning the beltpack.

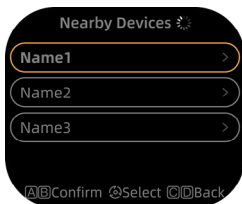

## Language

Tap [Language] to select the system language.



**Note:** Audio sources and call information will not change with the system language.

## Information

Select [Information] to switch the 3.5mm mode, restore factory settings, and view device and connection details.

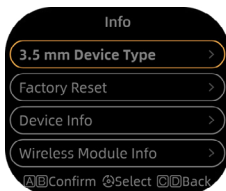

### 3.5mm Port Mode

When a 3.5mm device is connected, the beltpack will prompt you to select the device type manually. If selected incorrectly, the port may not work properly. You can change the device type here.

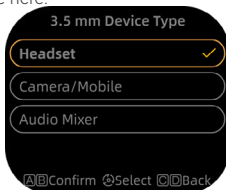

# Web Configuration

## Login to Web

1. Connect the central station's LAN port to your computer's network port using a standard RJ45 cable,

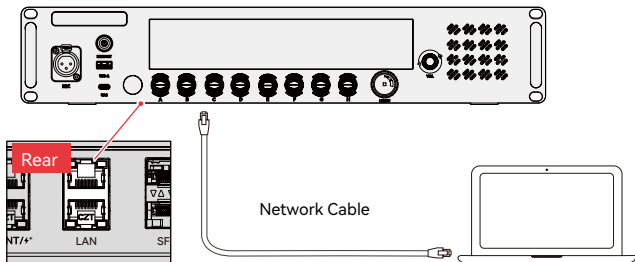

or connect your computer directly to any LAN port on the antenna.

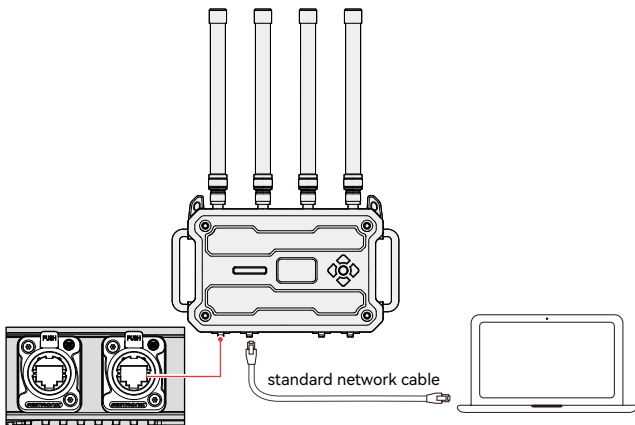

## Web Configuration

2. Set your computer's IPv4 address to the same subnet as the antenna. Open your browser, enter the antenna's IP address, and go to the web login page.



Welcome back  
**Login to your account**

User

Password

忘记密码

3. Log in using the default credentials (Username: admin; Password: 12345678) or your custom username and password to access the web configuration interface.

# Web Configuration

## Log in to the Web Interface

1. Use a standard RJ45 Ethernet cable to connect the LAN port (RJ45) on the back of the Geo Central Station to the Ethernet port of a computer.

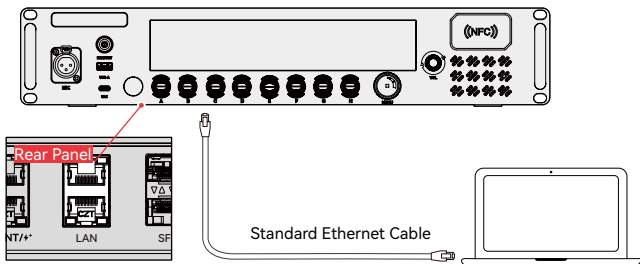

Alternatively, connect the computer's Ethernet port directly to any LAN port (RJ45) on the bottom of the Solidcom ANT01 antenna.

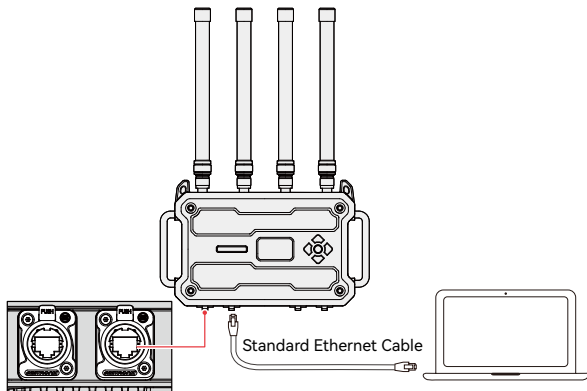

## ■ Accessing the Web Configuration Page

### 1. Check the IP Address and Password of the Station or Antenna

For the Geo Central Station: Press and hold the Menu button on the central station  
-> select Network -> select DHCP Settings to view the IP address, web login username, and password.

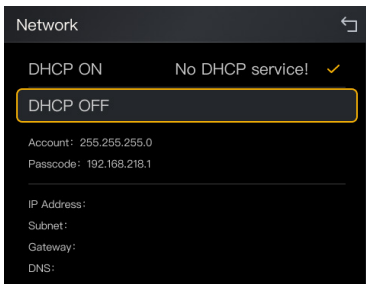

### 2. Configure the Computer's Network Segment

- Connect the computer to the station's RJ45 LAN port using an Ethernet cable.
- Set the computer's network adapter IP address to 192.168.218.XXX.
- The default IP address of the station is 192.168.218.XXX, with a subnet mask of 255.255.255.0.

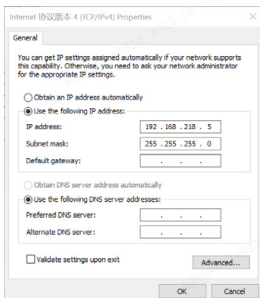

### 3. Log in to the Web Interface

- Open a browser on the computer and enter the station's IP address.
- On the login page, enter the username and password (default username: admin; password: 12345678) to access the web configuration interface of the Geo Central Station.



Welcome back  
**Login to your account**

Username

admin

Password

12345678

Login

# Web Module Functions

## Home

1. When entering the web system configuration interface, you can perform the following operations:

### [Home]

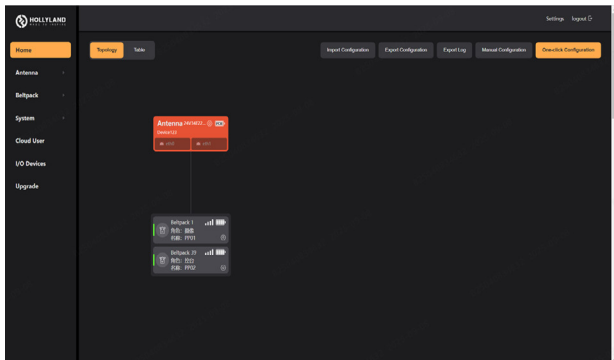

1. By default, the homepage displays the device connection topology, which can also be switched to a table view.

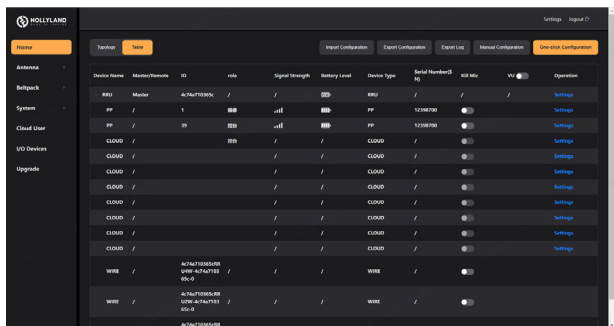

## Web Module Functions

2. Supports importing and exporting configuration files.
3. Click Manual Configuration to enter the configuration menu. Here, you can manually assign roles to all beltpacks that can connect to the Geo Central Station (including offline devices).

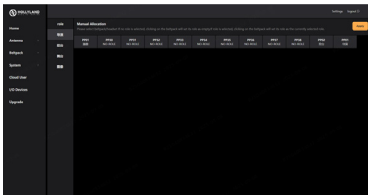

4. Click One-click Configuration to enter the configuration menu. In this interface, you can set the number of users for each role and click Apply in the upper right corner to save and push the configuration to all devices under the station.

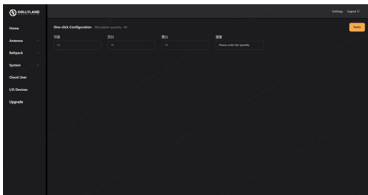

### Note:

Role assignment is carried out based on the order and quantity in the list, following these rules:

- a. Online beltpacks
- b. Beltpacks on the charging base (charging base must be connected to the central station)
- c. Beltpacks that come online during stages a and b
- d. Beltpacks placed on the charging base during stages a and b (charging base must be connected to the central station)
- e. Beltpacks that come online during stages c and d
- f. Beltpacks placed on the charging base during stages c and d (charging base must be connected to the central station)

## Geo Central Station Configuration

### 【Key Management】

Manage the 8 keys of the central station, including key color, light brightness, audio volume, audio source & call function, and key mode.

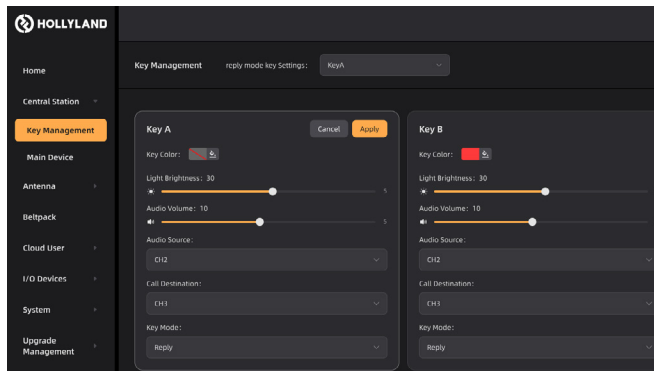

1. Audio Source: Select up to 4 audio sources (4-wire, 2-wire, beltpack, channel, or cloud user) from the dropdown menu to communicate with the central station.
2. Call Function: Assign a call function to the key. When configured, pressing and holding the key for 2 seconds will trigger a Call to the devices in that channel. Devices in the channel will vibrate, and if both caller and callee have audio sources configured, the callee can hold the Reply key to respond via voice.
3. Key Mode: Five modes are available:
  - Talk & Force Listen – Default: Talk enabled; can toggle talk on/off.
  - Listen-only – Default: Listen enabled; can toggle listen on/off.
  - Talk & Listen – Default: Talk and listen enabled; can toggle both on/off together.
  - PTT & Force Listen – Default: Talk disabled, forced listen enabled; press PTT to talk, release to disable talk.
  - Announce – Default: Talk disabled, forced listen enabled; press to announce. Announce has the highest priority and interrupts others. Release to disable talk.

# Web Module Functions

## 【2-Wire Settings】

Supports Auto-Null adjustment.

Allows selecting input/output gain and setting the 2-wire mode as Clear-Com Standard Mode, RTS Single-Channel Mode, or RTS Dual-Channel Mode.

Supports cable and resistance compensation.

After modification, click Apply in the upper right corner to save the settings.

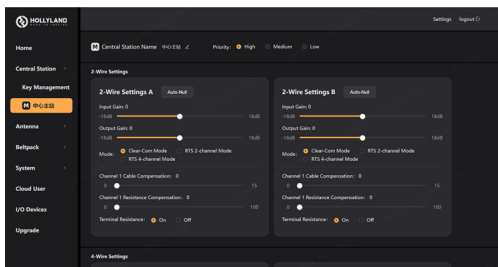

## 【4-Wire Settings】

Allows adjusting input/output gain and setting the 4-wire interface wiring sequence of the central station to Standard Mode or Cross Mode.

After modification, click Apply in the upper right corner to save the settings.

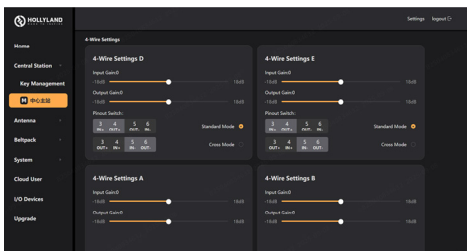

## 【Dante Settings】

Allows adjusting input/output gain for Dante.

After modification, click Apply in the upper right corner to save the settings.

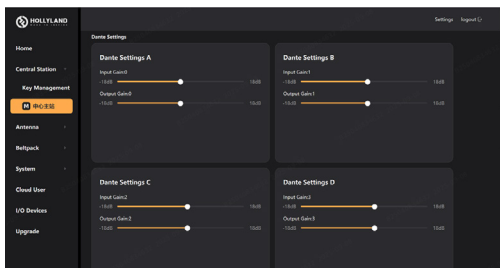

## 【Network Settings】

Manage LAN, WAN, and wireless configurations.

LAN Settings: Enable/disable DHCP, modify IP address, gateway, subnet mask, and DNS. Click Apply to save.

WAN Settings: Enable/disable DHCP, modify IP address, gateway, subnet mask, and DNS. Click Apply to save.

Wireless Settings: Enable/disable Wi-Fi & Bluetooth, modify Wi-Fi & Bluetooth names, view IP address. Click Apply to save.

### Note:

The Bluetooth name can only be modified using Chinese characters, English letters, or numbers. Chinese names are limited to 5 characters, while English letters and numbers are limited to 15 characters.

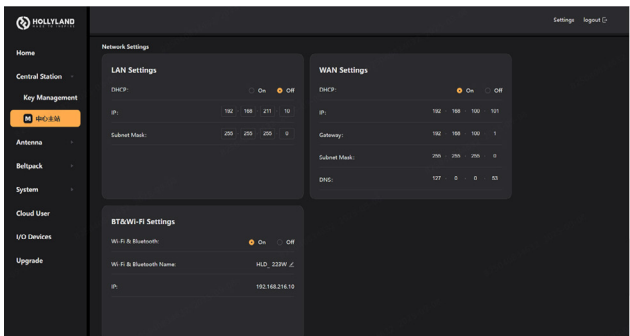

## 【Other Settings】

Manage language, display settings, restore factory defaults, and check firmware version information.

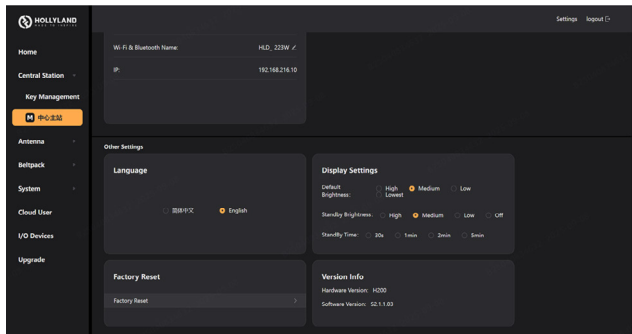

# Web Module Functions

## RRU Configuration

1. Rename the RRU and view the serial number (SN) of the RRU.

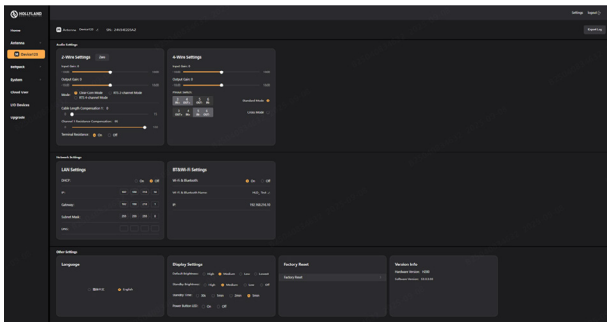

2. The Audio Settings section allows configuration of both 2-Wire (2W) and 4-Wire (4W) modes.

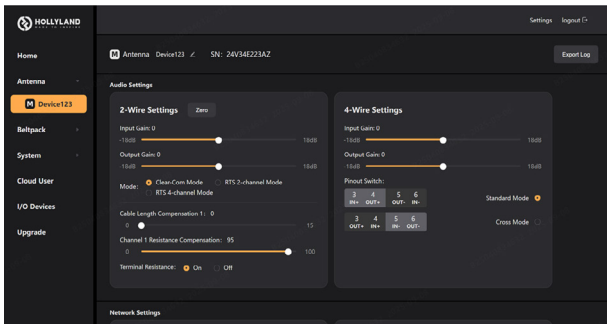

## Web Module Functions

### 2-Wire Settings

Supports one-click zeroing. Users can select the appropriate gain level according to input/output volume and configure the 2-wire mode as Clear-Com Standard Mode, RTS Single-Channel Mode, or RTS Dual-Channel Mode. Cable length compensation and resistance compensation can also be adjusted. Click Apply in the top-right corner to save the settings.

**2-Wire Settings**    Zero    Cancel    Apply

Input Gain: 3  
-18dB ————— 18dB

Output Gain: 0  
-18dB ————— 18dB

Mode:     Clear-Com Mode     RTS 2-channel Mode  
           RTS 4-channel Mode

---

Cable Length Compensation 1: 0  
0     ————— 15

Channel 1 Resistance Compensation: 95  
0     ————— 100

Terminal Resistance:     On     Off

## 4-Wire Settings

Users can select the appropriate gain level according to input/output volume and configure the 4-wire interface wiring of the central station to either Standard Mode or Cross Mode. Click Apply in the top-right corner to save the settings.

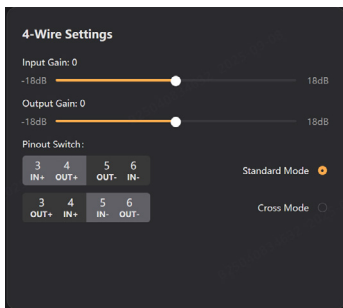

3. The Network Settings section allows configuration of both LAN Settings and Wireless Settings

## LAN Settings

In the LAN configuration section, users can enable or disable DHCP, modify the IP address, gateway, subnet mask, and DNS. Click Apply in the top-right corner to save the settings.

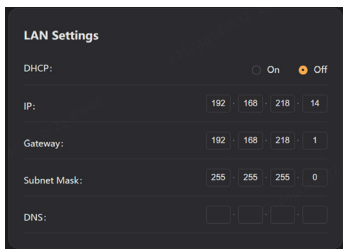

### Wireless Settings

In the wireless configuration section, users can enable or disable Wi-Fi & Bluetooth, modify the Wi-Fi & Bluetooth names, and view the IP address. Click Apply in the top-right corner to save the settings.

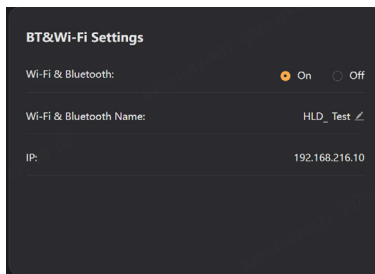

### 4. Other Settings

Language Settings: Switch the system language between Simplified Chinese and English. Click Apply in the top-right corner to save the settings.

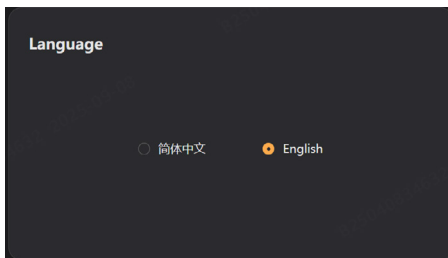

## Web Module Functions

### Display Settings

Adjust RRU display options, including screen brightness, standby brightness, standby time, and power-on indicator light. Click Apply in the top-right corner to save the settings.

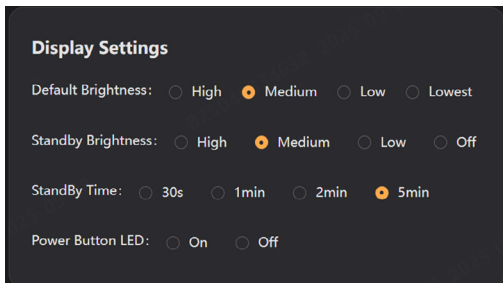

**Display Settings**

Default Brightness:  High  Medium  Low  Lowest

Standby Brightness:  High  Medium  Low  Off

StandBy Time:  30s  1min  2min  5min

Power Button LED:  On  Off

### Factory Reset

Click Factory Reset. A confirmation dialog will appear indicating the central station will be restored to factory defaults. Click Confirm to proceed.

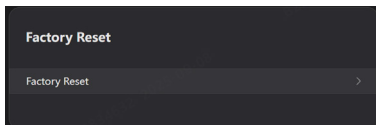

**Factory Reset**

Factory Reset >

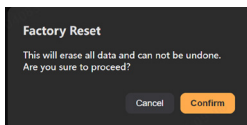

**Factory Reset**

This will erase all data and can not be undone.  
Are you sure to proceed?

# Web Module Functions

## Version Info

View the current hardware version and software version of the RRU.

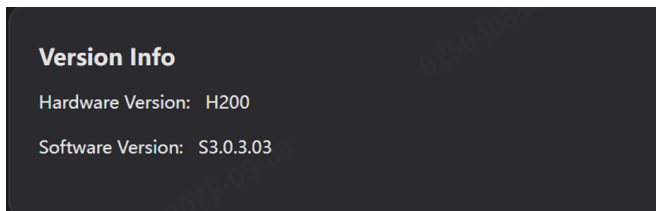

## Log Export

Click Export Log to export RRU logs in a compressed package format. The exported logs can be used by engineers for quick troubleshooting and analysis.

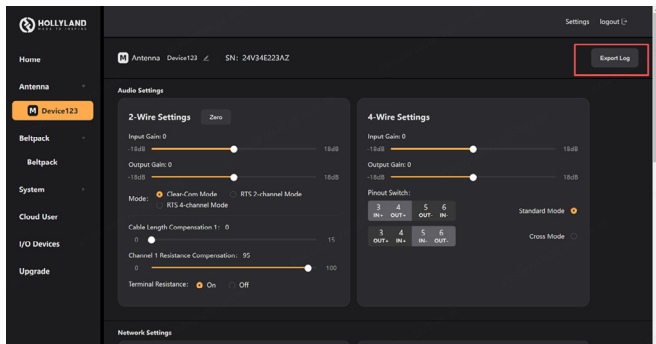

## Beltpack Configuration

1. On the Beltpack Configuration page, users can quickly view all beltpacks, including Beltpack Number, Beltpack ID, Role Name, Signal Strength, Battery Level, and SN information. Online beltpacks are highlighted.

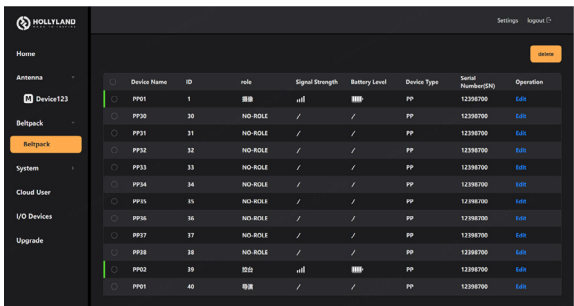

Device Name	ID	role	Signal Strength	Battery Level	Device Type	Serial Number(SN)	Operation
PP01	1	導演			PP	12398700	edit
PP30	30	NO-ROLE	/	/	PP	12398700	edit
PP31	31	NO-ROLE	/	/	PP	12398700	edit
PP32	32	NO-ROLE	/	/	PP	12398700	edit
PP33	33	NO-ROLE	/	/	PP	12398700	edit
PP34	34	NO-ROLE	/	/	PP	12398700	edit
PP35	35	NO-ROLE	/	/	PP	12398700	edit
PP36	36	NO-ROLE	/	/	PP	12398700	edit
PP37	37	NO-ROLE	/	/	PP	12398700	edit
PP38	38	NO-ROLE	/	/	PP	12398700	edit
PP02	39	監台			PP	12398700	edit
PP01	40	導演	/	/	PP	12398700	edit

2. Select a beltpack and click Delete. In the confirmation dialog that appears, click OK to remove the beltpack information.

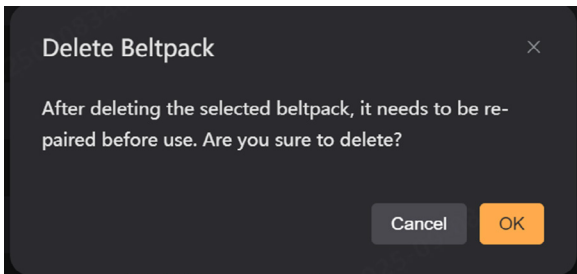

## Web Module Functions

- Click the Edit button on the right side of the backpack list to enter the detailed configuration page. After making adjustments, click Apply in the top-right corner to save the settings.

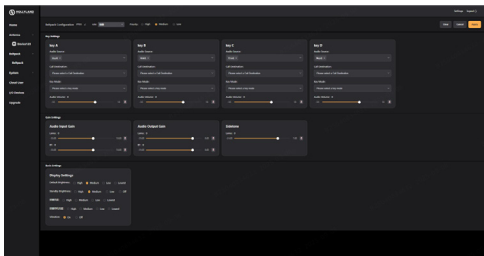

### Basic Settings

Configure regular screen brightness, standby screen brightness, and vibration switch.

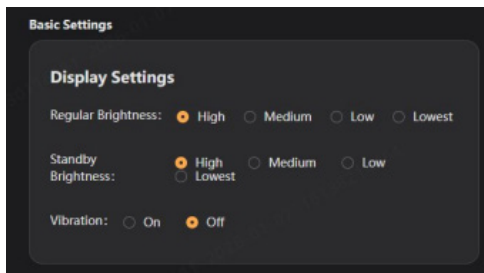

# Web Module Functions

## Gain Settings

Configure audio input gain, audio output gain, and sidetone output gain. Sidetone allows users to hear their own voice through the headset, which helps them monitor their speaking volume and status.

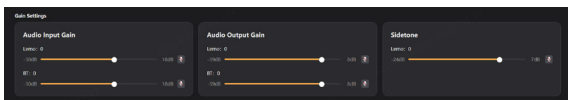

## Key Settings

Configure the functions of each beltpack key.

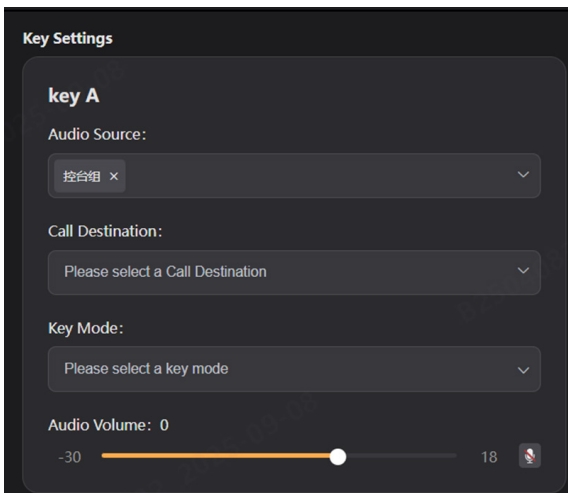

# Web Module Functions

## Audio Source

Use the dropdown menu to select up to four audio sources for communication with the beltpack. Supported sources include 4-Wire, 2-Wire, other beltpacks, channels, or cloud users.

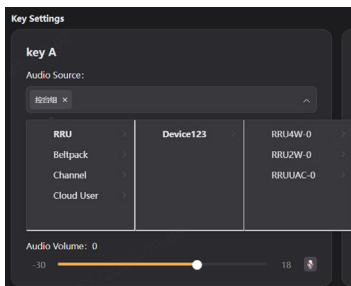

## Call Function

Assign a call function to the key. When configured, pressing and holding the key for 2 seconds will trigger a Call to the devices in that channel. Devices in the channel will vibrate, and if both caller and callee have audio sources configured, the callee can hold the Reply key to respond via voice.

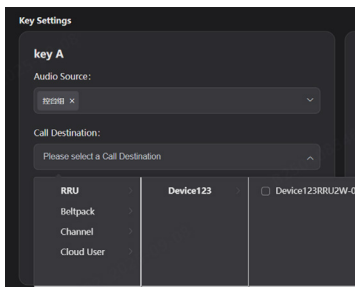

# Web Module Functions

## Key Mode

Five modes are available:

1. Talk & Force Listen – Default: Talk enabled; can toggle talk on/off.
2. Listen-only – Default: Listen enabled; can toggle listen on/off.
3. Talk & Listen – Default: Talk and listen enabled; can toggle both on/off together.
4. PTT & Force Listen – Default: Talk disabled, forced listen enabled; press PTT to talk, release to disable talk.
5. Announce – Default: Talk disabled, forced listen enabled; press to announce. Announce has the highest priority and interrupts others. Release to disable talk.

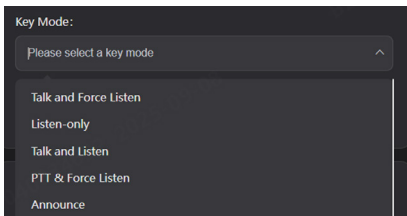

## Audio Volume

You can control the volume of the audio sources heard on this beltpack.

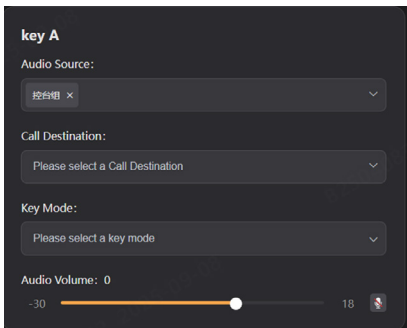

## Cascade System Configuration

### Role

From the System interface, click Role to enter the configuration menu. In this interface, you can view all preset roles and audio sources in the current system.

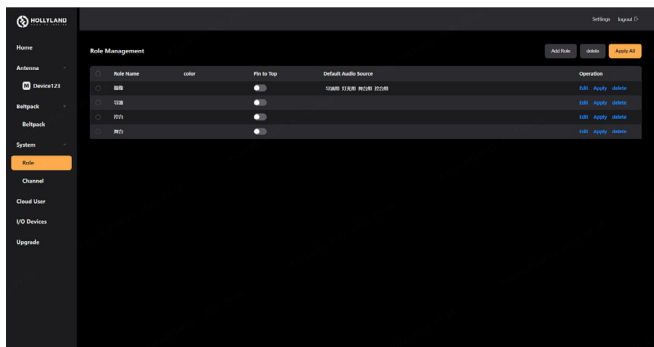

# Web Module Functions

Click Edit to open the role editing page, where you can configure the preset role's backpack keys, gain, and display settings. Click Apply to save and apply the configuration.

After configuring a preset role, go to the Backpack Management page and bind the backpack to the role. The backpack will then inherit the configuration scheme of the assigned role.

Role priority settings: A higher priority level corresponds to a 6 dB increase in output audio gain.

## Notes:

1. The Bluetooth name can only be modified using Chinese characters, English letters, or numbers. Chinese names are limited to 5 characters, while English letters and numbers are limited to 15 characters.
2. Role configurations can be restored to their default state by performing a factory reset. A factory reset will delete all roles.
3. After a role is deleted, the previously bound backpacks will enter an "Unassigned" state and must be reconfigured.
4. Deleting a role does not clear the existing configuration on backpacks that were previously assigned to that role.

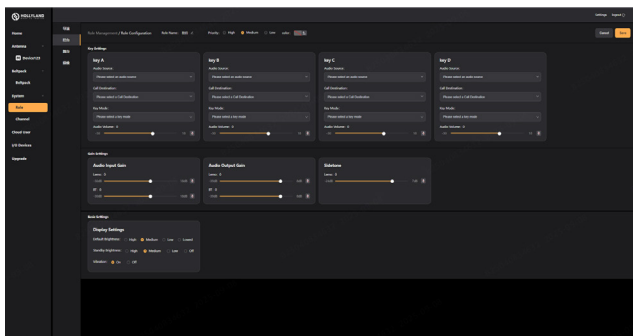

# Web Module Functions

## Channel

From the System interface, click Channel to enter the configuration menu. In this interface, you can view all groups in the current system as well as all devices within each group. Users can also add or delete groups, or modify group names.

### Note:

The CH1 channel does not support renaming the group or deleting it.

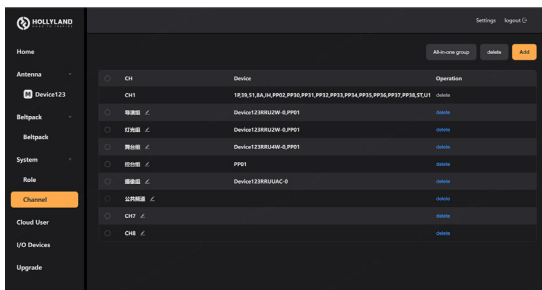

By clicking the All-in-one Group button and confirming in the pop-up dialog, all beltpacks, cloud users, and wired devices in the system will be assigned to one single group.

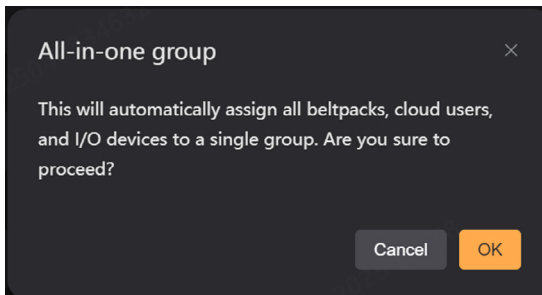

# Web Module Functions

## Cloud User Configuration

Click Cloud User to enter the cloud user configuration menu. In this interface, you can view the preset cloud users in the system. A total of up to 8 cloud user seats can be preset. In Standalone Mode, up to 4 cloud users can be connected simultaneously. When used with Geo Central Station, up to 8 cloud users can be connected.

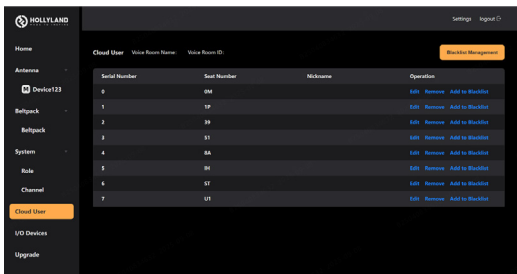

Click Edit to open the configuration page of a cloud user seat. Users can directly assign a preset system role to the seat, and the role's configuration will be synchronized to the cloud user seat. Alternatively, users may configure the seat individually by setting its communication audio sources, call functions, and key modes.

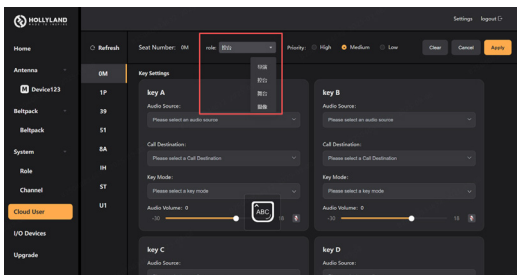

# Web Module Functions

- After joining a cloud call through the HOLLYVOX App, users can select a seat number in the app to automatically inherit the call permissions and settings of the assigned role. On the web interface, all cloud call roles currently connected to the system can be viewed.
- Click Remove to disconnect a cloud call user from the seat. Click Add to Blacklist to block the user, who will then appear in Blacklist Management, where the restriction can be lifted if needed.

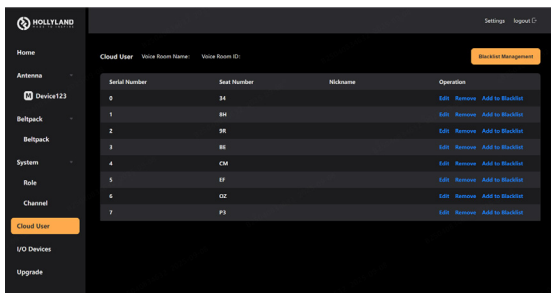

## Wired I/O Interface Configuration

Click I/O Devices to enter the wired I/O configuration page. Users can configure input and output audio sources for 4-Wire (4W), 2-Wire (2W), and UAC. By deselecting "IN & OUT Merge", input and output can be configured separately.

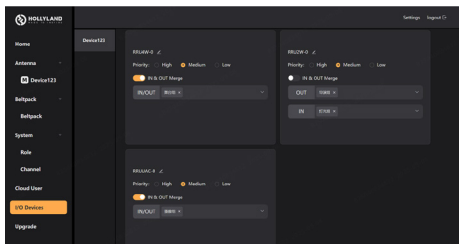

## Upgrade

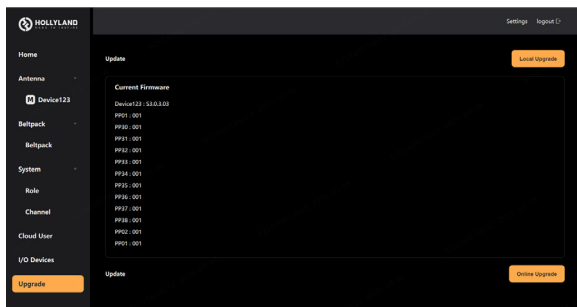

Click Upgrade to enter the upgrade management page. In this interface, users can view the version information of all devices in the current system. Users can click Local Upgrade to select a local installation package for upgrading, or click Online Upgrade to perform version checks and upgrades for all devices in the system.

## ■ Connect the Geo Central Station / Solidcom ANT01

1. Download the HOLLYVOX app.



2. Launch the app.

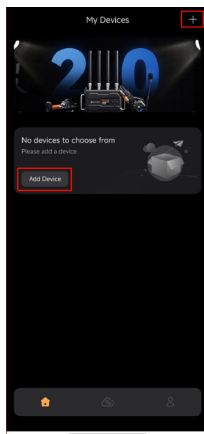

# App Configuration

Click the + icon in the top-right corner to add a new device, and select Solidcom ANT01 Antenna.



## App Configuration

Ensure the device is powered on and has successfully started. Also confirm that the phone's location services and Bluetooth are enabled. Select Completed the above step, then click Next.

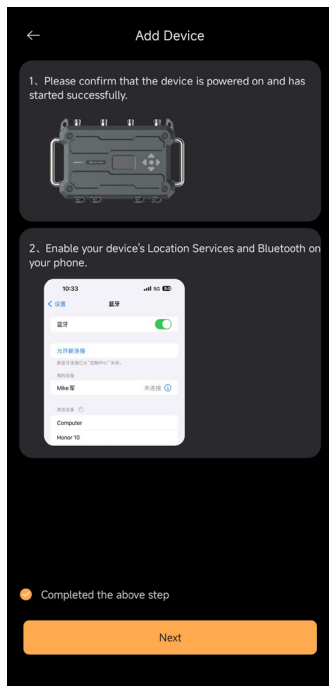

## App Configuration

From the list, select the device by its Bluetooth name to complete binding and connection.

Note: The Bluetooth name of the device can be modified on the Web interface.

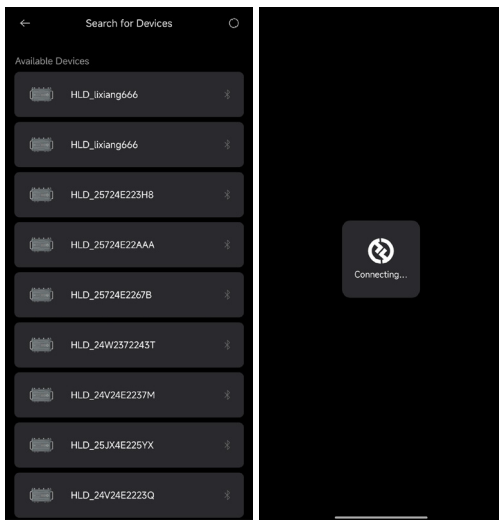

## Home

1. When you connect to the App and enter the configuration interface, the following operations are available:

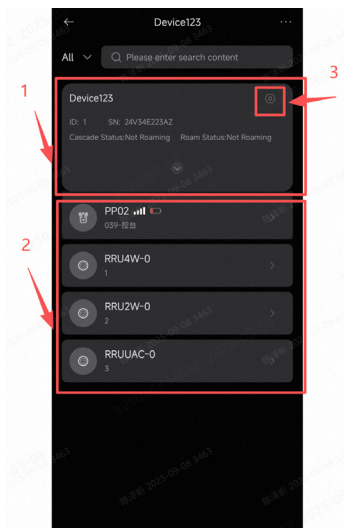

- 1) View information for the central station named Device123, including ID, SN, roaming status, cascade status, and options for one-click or manual grouping.
- 2) View information for the online beltpacks under central station (Device123):
  - Beltpack name and assigned role
  - Beltpack signal strength and battery level
- 3) Configure system settings for the central station, including: 2-Wire Settings, 4-Wire Settings, DHCP Settings, BT & Wi-Fi Settings, Display Settings, Language Settings, Version Information and Factory Reset Settings.

# App Module Functions

## RRU Configuration

Tap the gear icon to access the RRU configuration page.

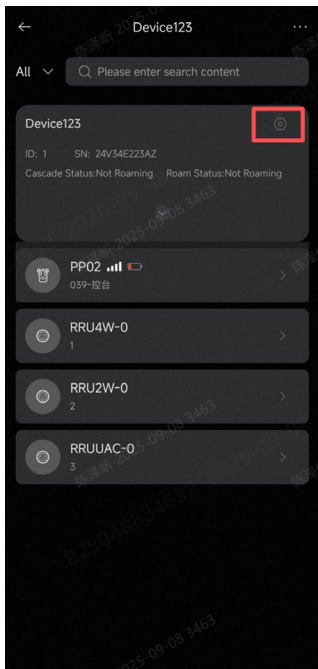

## Central Station

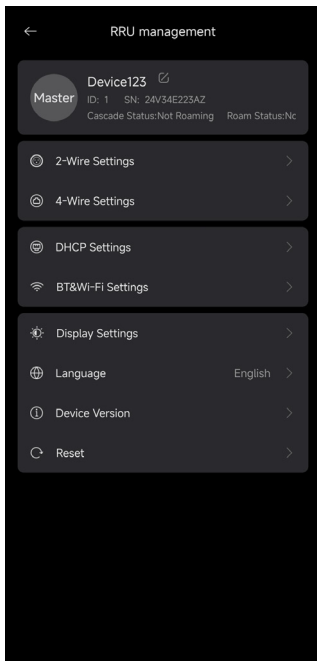

# App Module Functions

## 2-Wire Settings

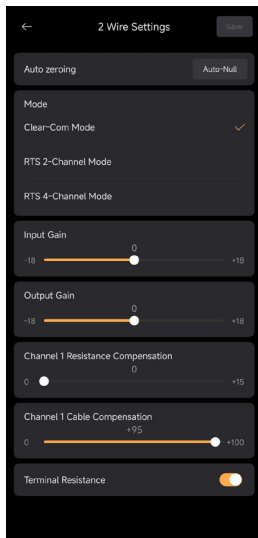

## 4-Wire Settings

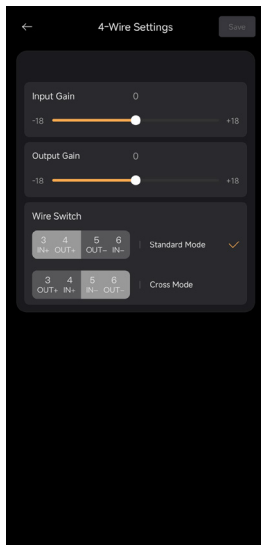

## LAN Settings

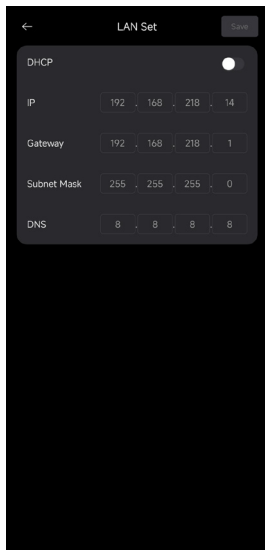

The screenshot shows the 'LAN Set' configuration screen. At the top, there is a back arrow on the left, the title 'LAN Set', and a 'Save' button on the right. Below the title, there is a 'DHCP' toggle switch which is currently turned off. Underneath, there are four rows of input fields for network configuration: 'IP' (192, 168, 218, 14), 'Gateway' (192, 168, 218, 1), 'Subnet Mask' (255, 255, 255, 0), and 'DNS' (8, 8, 8, 8).

LAN Set

DHCP

IP 192 . 168 . 218 . 14

Gateway 192 . 168 . 218 . 1

Subnet Mask 255 . 255 . 255 . 0

DNS 8 . 8 . 8 . 8

## BT & Wi-Fi Settings

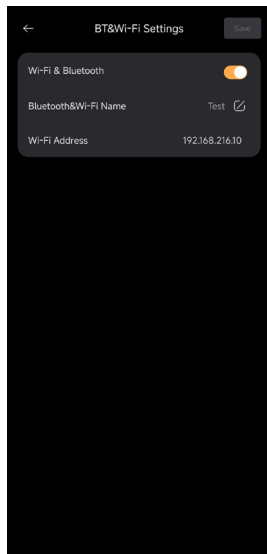

The screenshot shows the 'BT&Wi-Fi Settings' configuration screen. At the top, there is a back arrow on the left, the title 'BT&Wi-Fi Settings', and a 'Save' button on the right. Below the title, there is a 'Wi-Fi & Bluetooth' toggle switch which is currently turned on. Underneath, there are two rows of settings: 'Bluetooth&Wi-Fi Name' with a 'Test' button and a copy icon, and 'Wi-Fi Address' with the value '192.168.216.10'.

BT&Wi-Fi Settings

Wi-Fi & Bluetooth

Bluetooth&Wi-Fi Name Test

Wi-Fi Address 192.168.216.10

# App Module Functions

## Display Settings



## Language Settings

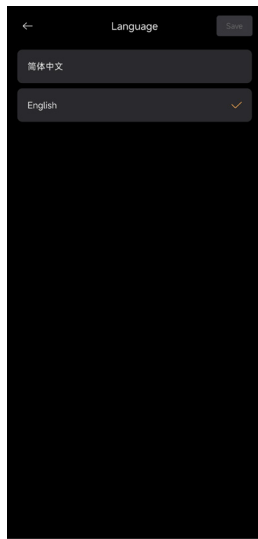

## Device Version

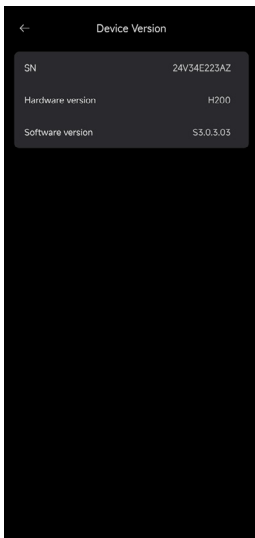

## Factory Reset

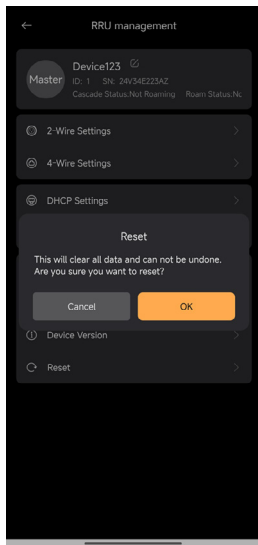

## Geo Central Station Configuration

Tap the Central Station in the APP to enter the central station configuration page. As shown in the figure, the following settings can be configured: Mic-Kill, Key Light Management, 2-Wire Settings, 4-Wire Settings, Dante Settings, Microphone Settings, Walkie-Talkie Settings, SA Settings, PGM Settings, LAN & SFP Settings, WAN Settings, BT & Wi-Fi Settings, Display Settings, Language Settings, Version Information and Factory Reset Settings.

※ The configuration process is the same as on the Web interface and will not be repeated here.

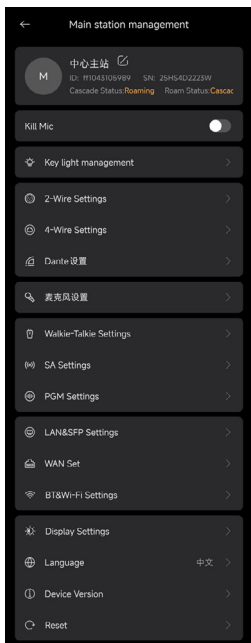

# App Module Functions

## ■ Beltpack Configuration

Tap the area highlighted in red in the figure to enter the beltpack configuration page.

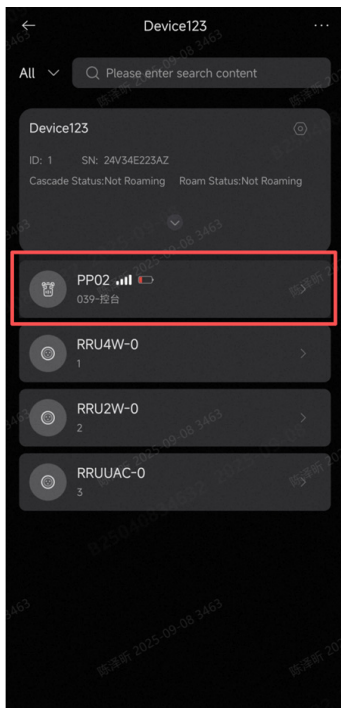

# App Module Functions

On the Beltpack Settings page, you can configure: Beltpack Name, Role, Priority, Mic-Kill, Key Settings, Gain Settings, Display Settings.

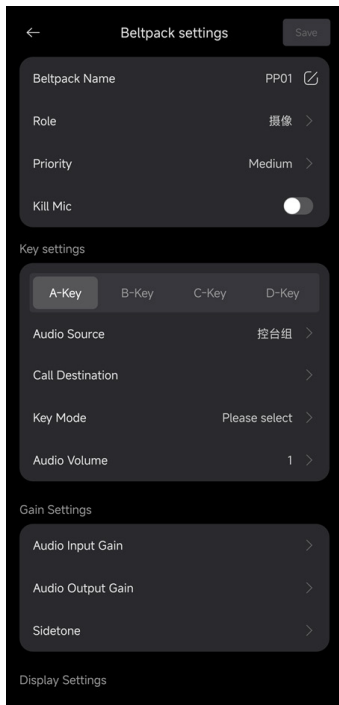

# App Module Functions

## Tap Audio Source

to enter the audio source selection page. The currently selected audio sources are displayed at the bottom of the screen.

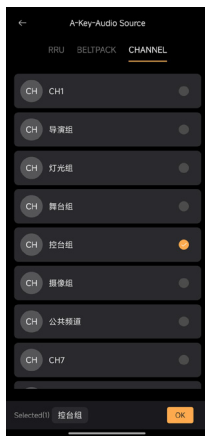
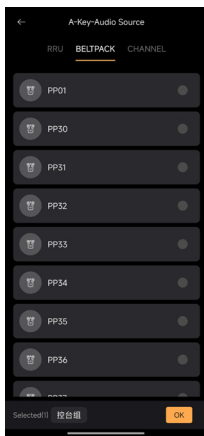
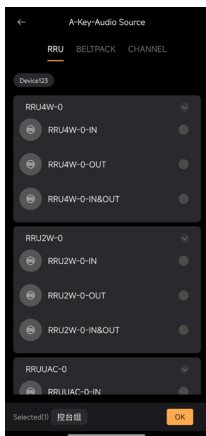

## App Module Functions

Tap Call Function to enter the call function audio source selection page. The currently selected audio sources are displayed at the bottom of the screen.

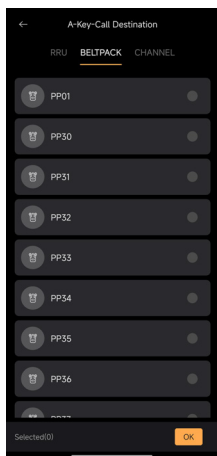

## App Module Functions

Tap Key Mode, five modes are available:

1. Talk & Force Listen – Default: Talk enabled; can toggle talk on/off.
2. Listen-only – Default: Listen enabled; can toggle listen on/off.
3. Talk & Listen – Default: Talk and listen enabled; can toggle both on/off together.
4. PTT & Force Listen – Default: Talk disabled, forced listen enabled; press PTT to talk, release to disable talk.
5. Announce – Default: Talk disabled, forced listen enabled; press to announce. Announce has the highest priority and interrupts others. Release to disable talk.

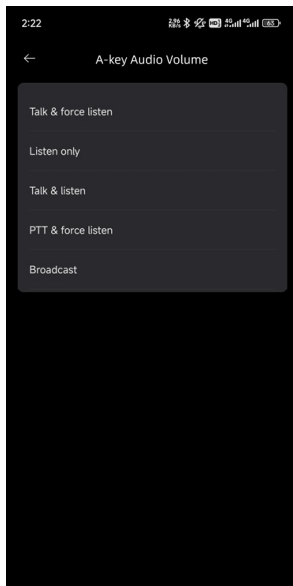

# App Module Functions

Tap Audio Volume to adjust the input gain.

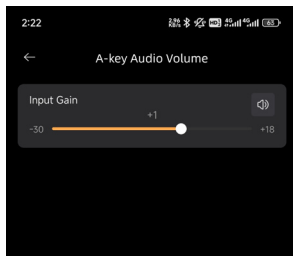

## App Module Functions

In Gain Settings section, tap Audio Input Gain to adjust the gain for LEMO and Bluetooth audio inputs.

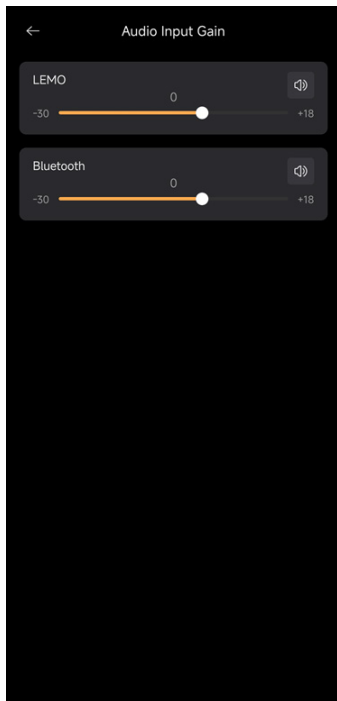

## App Module Functions

In Gain Settings section, tap Audio Output Gain to adjust the gain for LEMO and Bluetooth audio outputs.

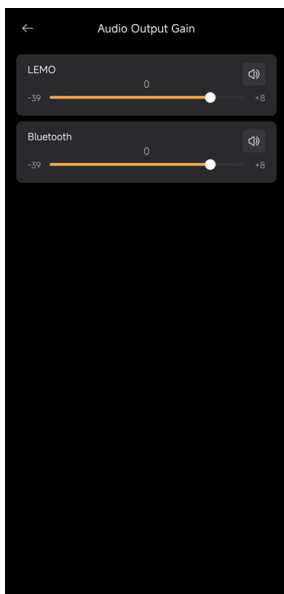

## App Module Functions

In Gain Settings section, tap Sidetone to adjust the sidetone gain for LEMO output.

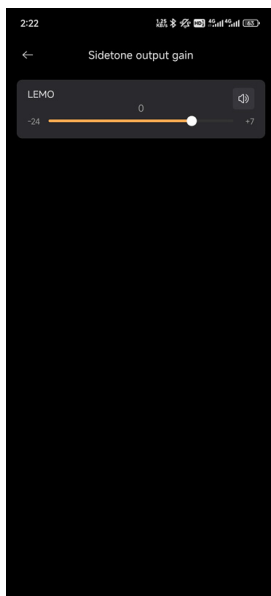

## App Module Functions

In Display Settings section, tap Screen Brightness to adjust the screen brightness level.

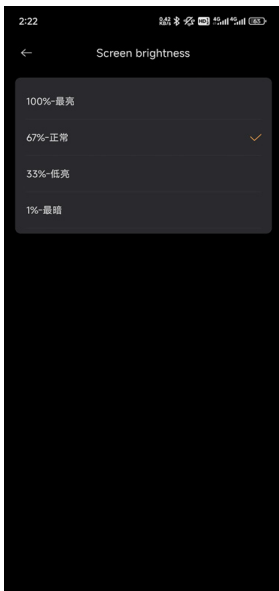

## App Module Functions

In Display Settings section, tap Standby Screen Brightness to adjust the screen brightness level during standby.

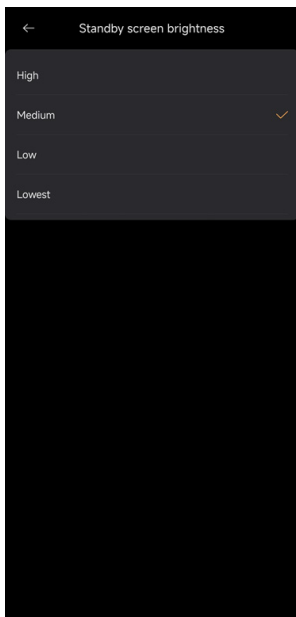

## Cascade System Configuration

### Role

From the homepage, tap ... to enter the Settings page.

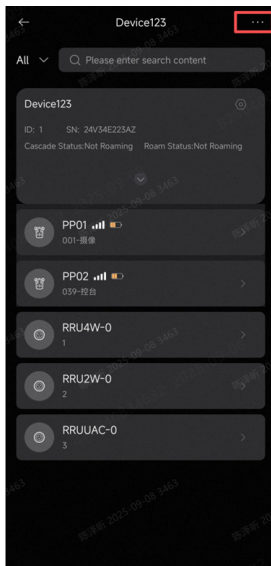

# App Module Functions

Tap Role Management.

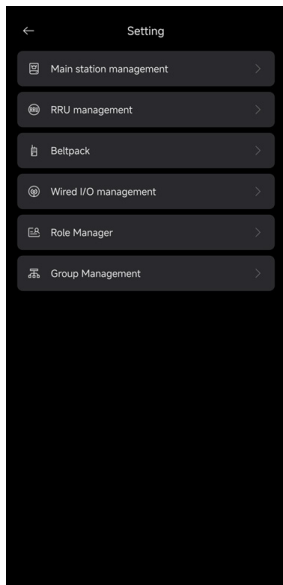

On the Role Management page, tap the + icon in the top-right corner to add a new role.



## App Module Functions

On the Add New Role page, configure the role settings such as Role Name and Key Settings. After completing the configuration, tap Save to apply.

← Add New Role Save

Role Name \* Please enter

Priority Medium >

Key settings

A-Key B-Key C-Key D-Key

Audio Source >

Call Destination >

Key Mode Talk & force listen >

Audio Volume 0 >

Gain Settings

Audio Input Gain >

Audio Output Gain >

Sidetone >

Display Settings

Screen brightness Medium >

Standby screen brightness Medium >

# App Module Functions

## Group Configuration

On the app, you can manage role groups by tapping Group Management to enter the Group Management page.

Tap the + icon in the top-right corner to create a new group. Tap Edit to modify the group name.

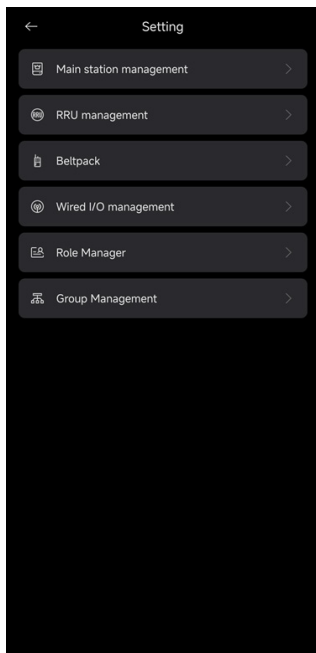

# App Module Functions

## Cloud User Configuration

Tap Create to create a new voice room.

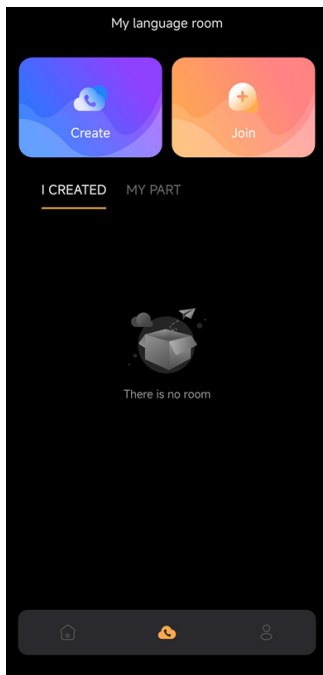

## App Module Functions

A prompt will appear indicating that a central station needs to be added. Tap Add Device.

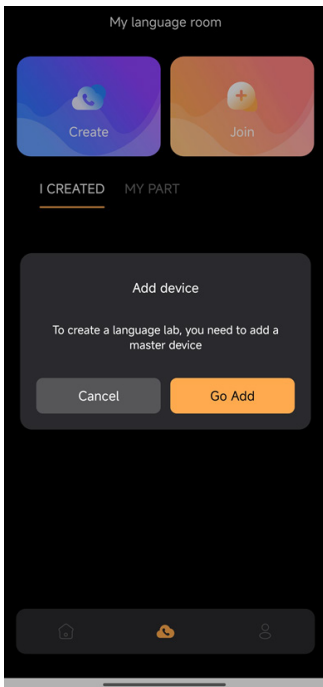

## App Module Functions

On the device side, go to System Settings to find the dynamic code. Enter this code in the app.

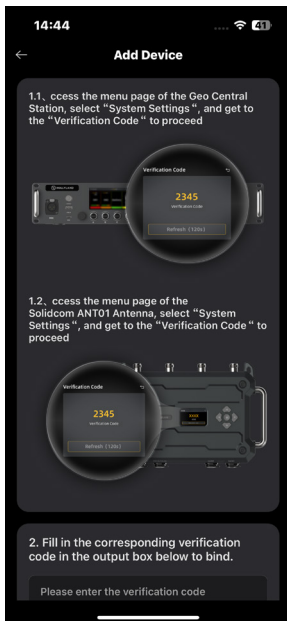

# App Module Functions

After entering the verification code, tap Next.

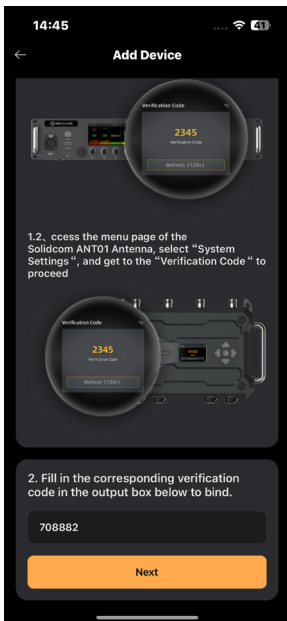

## App Module Functions

You may enter a remark, then tap Done to complete the binding.

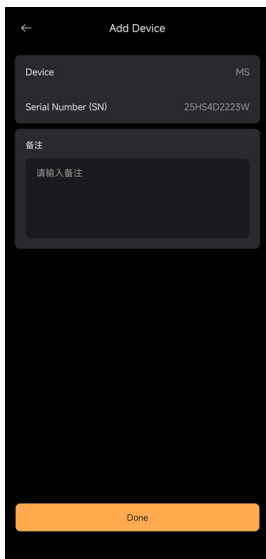

← Add Device

Device MS

Serial Number (SN) 25HS4D2223W

备注

请输入备注

Done

## App Module Functions

Once the device is bound, enter the Voice Room Name and Password, then tap OK.

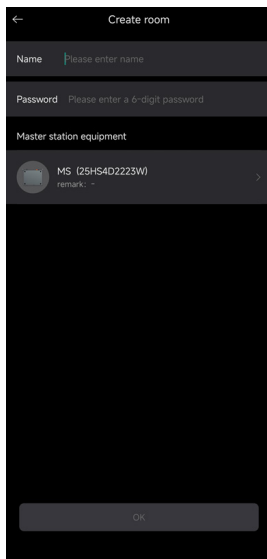

The screenshot shows a mobile application interface for creating a room. At the top, there is a back arrow and the title "Create room". Below the title are two input fields: "Name" with a placeholder "Please enter name" and "Password" with a placeholder "Please enter a 6-digit password". Underneath these fields is a section titled "Master station equipment". This section contains a single entry: a circular icon on the left, followed by the text "MS (25HS4D2223W)" and "remark: -" below it, and a right-pointing chevron icon. At the bottom of the screen is a large, light-colored button labeled "OK".

## App Module Functions

After the voice room is created, tap Start to enable cloud communication.

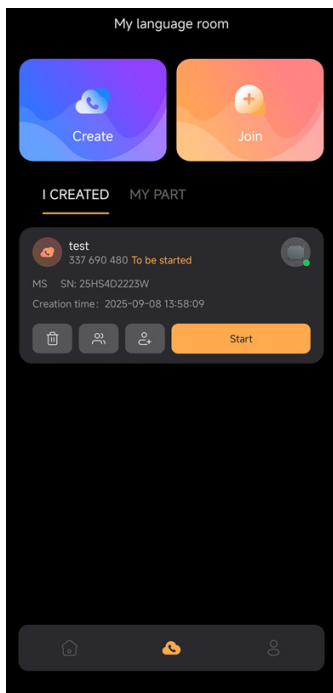

# App Module Functions

The voice room is now active. Tap to enter.

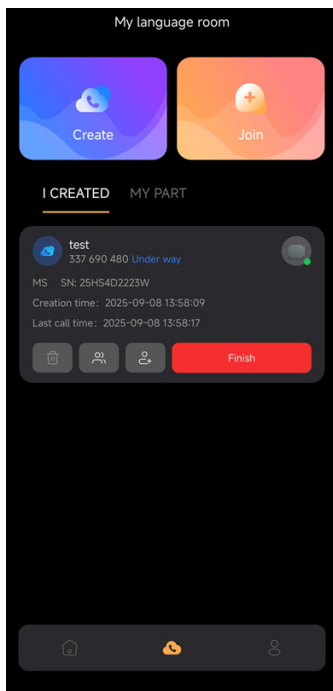

## App Module Functions

Enter the seat number of the cloud communication user (seat numbers can be viewed on the Web).

← test

⋮

⋮

Call in progress  
00:00:07

Seat number ⓘ Please enter the seat number

Name of the Room test

Room ID 337-690-480

Master station equipment MS

creator ()moma\_NZpYU3

enter

## App Module Functions

After entering the voice room, each cloud communication user functions as a wireless beltpack. Within the app, users can simulate pressing the beltpack button and adjust audio gain.

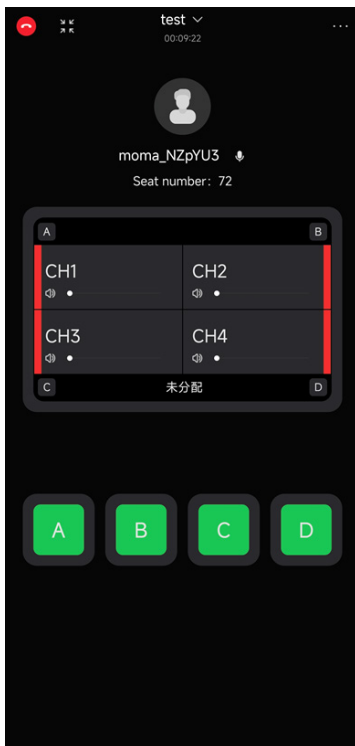

# App Module Functions

## Wired I/O Interface Configuration

Tap the area highlighted in red to enter the wired I/O configuration page.



## App Module Functions

Users can configure input and output audio sources for 4-Wire (4W), 2-Wire (2W), and UAC. By deselecting "IN & OUT Merge", input and output can be configured separately.

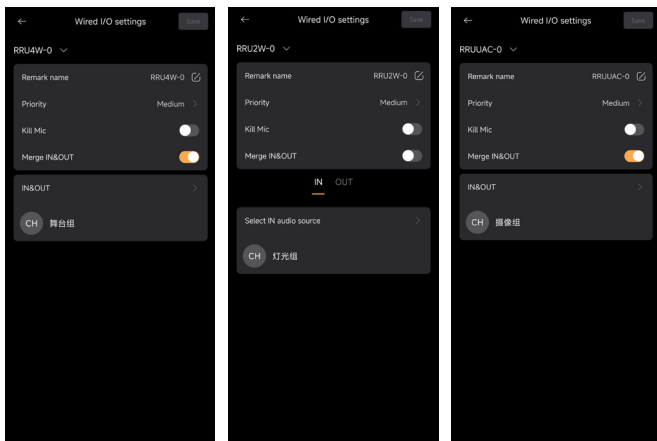

# Product Specifications

## Geo Central Station

Specifications	
Power Consumption	44W
POE Output Power	120W; 60W/Port
DC Input Voltage	46~54V
AC Input Voltage	100~240V
Dimensions	482.6*88.1*385
Weight	7.25kg
Operating Temperature	-10~45°C
Storage Temperature	-20~60°C
LEMO Audio Specifications	
Frequency Response (Input)	150 Hz - 7 kHz
Maximum Input Sound Pressure Level	115dB SPL
Noise Cancellation Depth	20dB
Distortion Rate	<1%
Signal-to-Noise Ratio	67dB
Output Sound Pressure Level	113dB SPL Max

# Product Specifications

## Solidcom ANT01

Solidcom ANT01 Antenna			
Model	Solidcom ANT01		
Product Name	Full-Duplex Wireless Intercom System		
LOS Range	500m		
Operating Frequency	<table border="1"> <tr> <td>CE: DECT: 1880 - 1900 MHz BT: 2402 - 2480 MHz WIFI: 2412 - 2472 MHz</td> <td>FCC: DECT: 1920 - 1930 MHz BT: 2402 - 2480 MHz WIFI: 2412 - 2472MHz</td> </tr> </table>	CE: DECT: 1880 - 1900 MHz BT: 2402 - 2480 MHz WIFI: 2412 - 2472 MHz	FCC: DECT: 1920 - 1930 MHz BT: 2402 - 2480 MHz WIFI: 2412 - 2472MHz
CE: DECT: 1880 - 1900 MHz BT: 2402 - 2480 MHz WIFI: 2412 - 2472 MHz	FCC: DECT: 1920 - 1930 MHz BT: 2402 - 2480 MHz WIFI: 2412 - 2472MHz		
Transmit Power	<table border="1"> <tr> <td>CE: DECT: ≤ 24 dBm BT: ≤ 5.83 dBm WIFI: ≤ 12.7 dBm</td> <td>FCC: DECT: ≤ 20 dBm BT: ≤ 4.88 dBm WIFI: ≤ 22.35 dBm</td> </tr> </table>	CE: DECT: ≤ 24 dBm BT: ≤ 5.83 dBm WIFI: ≤ 12.7 dBm	FCC: DECT: ≤ 20 dBm BT: ≤ 4.88 dBm WIFI: ≤ 22.35 dBm
CE: DECT: ≤ 24 dBm BT: ≤ 5.83 dBm WIFI: ≤ 12.7 dBm	FCC: DECT: ≤ 20 dBm BT: ≤ 4.88 dBm WIFI: ≤ 22.35 dBm		
Bandwidth	<table border="1"> <tr> <td>DECT: 1.728 MHz BT: 1 MHz WIFI: 20 MHz</td> </tr> </table>	DECT: 1.728 MHz BT: 1 MHz WIFI: 20 MHz	
DECT: 1.728 MHz BT: 1 MHz WIFI: 20 MHz			
Modulation Mode	<table border="1"> <tr> <td>DECT: GFSK BT: GFSK WIFI: OFDM</td> </tr> </table>	DECT: GFSK BT: GFSK WIFI: OFDM	
DECT: GFSK BT: GFSK WIFI: OFDM			
Receiver Sensitivity	-90 dBm		
Antenna Gain	4dB		
Power Consumption	15.5W		
POE Output Power	≤ 45W		
POE Input Power	≤ 60W		
V/G Mount Battery Voltage Range	11 - 30V		
Dimensions	302mm × 188.56mm × 64.6mm		
Weight	1987g		
Operating Temperature	-10 - 45°C		
Storage Temperature	-20 - 60°C		

# Product Specifications

## Solidcom BPK01

Solidcom BPK01 Beltpack		
Model	Solidcom BPK01	
Product Name	Full-Duplex Wireless Intercom System	
LOS Range	500m	
Operating Frequency	CE: DECT: 1880 - 1900 MHz BT: 2402 - 2480 MHz	FCC: DECT: 1920 - 1930 MHz BT: 2402 - 2480 MHz
Transmit Power	CE: DECT: ≤ 24 dBm BT: ≤ 5.92 dBm	FCC: DECT: ≤ 20 dBm BT: ≤ 7.32 dBm
Bandwidth	DECT: 1.728 MHz BT: ≤ 1 MHz	
Modulation Mode	DECT: GFSK BT: GFSK/π/4-DQPSK/8DSK	
Receiver Sensitivity	-90 dBm	
Battery Life	> 15h	
Dimensions	114.65mm × 89.2mm × 61.8mm	
Weight	305g	
Operating Temperature	-10~45°C	
Storage Temperature	-20~60°C	
LEMO Audio		
Input Frequency Response	150Hz-7KHz	
Maximum Input SPL	115 dBSPL	
Noise Cancellation Depth	20dB	
Distortion	< 1%	
Signal-to-noise Ratio (SNR)	67dB	
Output SPL Level	113 dBSPL max	

## Product Specifications

### Charging Base

Specifications	
Product Model	Solidcom BPK01
Product Name	Wireless Intercom System
Operating Voltage	5.2V
Operating Current	1.15A
Output Power	62W (for 10 belt packs)
Charging Time	3.5 hours (for 10 belt packs)
Maximum Data Transmission Rate	95.8Mbps
Dimensions	377.79*193.62*65.58mm
Weight	1455g
Operating Temperature	-10~45°C
Storage Temperature	-20~60°C

If you encounter any problems in using the product or need any help, please contact Hollyland Support Team via the following ways:

 Hollyland User Group

 HollylandTech

 HollylandTech

 HollylandTech

 support@hollyland.com

 www.hollyland.com

## Statement

All copyrights belong to Shenzhen Hollyland Technology Co., Ltd. Without the written approval of Shenzhen Hollyland Technology Co., Ltd., no organization or individual may copy or reproduce part or all of any written or illustrative content and disseminate it in any form.

## Trademark Statement

the trademarks are owned by Shenzhen Hollyland Technology Co., Ltd.

## Note:

Due to product version upgrades or other reasons, this User Manual will be updated from time to time. Unless otherwise agreed, this document is provided as a guide for use only. All representations, information, and recommendations in this document do not constitute warranties of any kind, express, or implied.

# **HOLLYVIEW**

**Powered by Hollyland**

**Manufacturer:** Shenzhen Hollyland Technology Co., Ltd.

**Address:** 8F, 5D Building, Skyworth Innovation Valley, Tangtou Road, Shiyan Street, Baoan District, Shenzhen, 518108, China

**MADE IN CHINA**