



Hollyland Solidcom C1 Pro - Hub4S

User Manual
V1.0.0





Introduction

Thank you for purchasing Hollyland Solidcom C1 Pro full-duplex wireless noise-cancelling intercom system.

The Solidcom C1 Pro - Hub4S is a full-duplex wireless noise-cancelling intercom system engineered to provide clear audio and all-day wearing comfort in a truly wireless design with no belt-pack required. The system operates in the 1.9GHz band, providing a reliable LOS range of up to 1,100ft (350m).

This User Manual will help you through the installation and use of the equipment.



Packing List

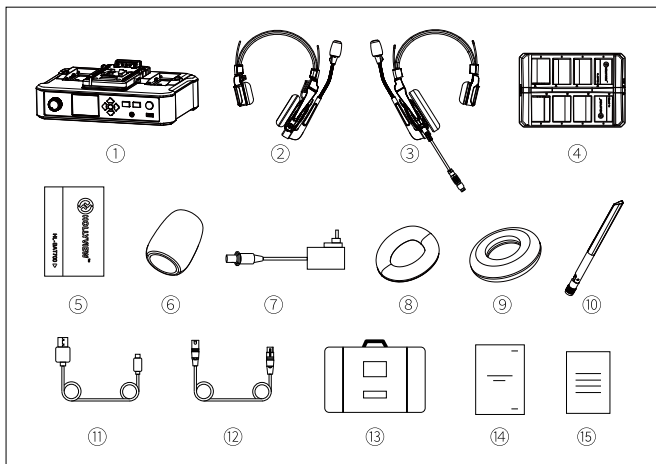

Solidcom C1 Pro - Hub4S Intercom Headset Package

①	Hub	x 1
②	Remote Headset (With Blue Nameplate)	x 4
③	0B10 Wired Headset (With Red Nameplate)	x 1
④	8-Slot Charging Case	x 1
⑤	Headset Battery	x 8
⑥	Microphone Cushion	x 5
⑦	12V/2A DC Adapter	x 2
⑧	Over-ear Leather Cushion	x 5
⑨	On-ear Foam Cushion	x 5
⑩	High-Gain Antenna	x 4
⑪	USB-A to USB-C Cable	x 1
⑫	3-Pin XLR Male to 3-Pin XLR Female Cable	x 1
⑬	Storage Case	x 1
⑭	User Manual	x 5
⑮	Warranty Card	x 1

Note: The quantity of the items depends on the product configuration.

Quick Guide

Installing the Hub Antennas

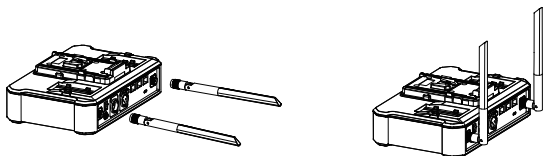

Powering on the Hub

- Connect the 12V/2A DC adapter to the hub.
- Switch on the Hub.

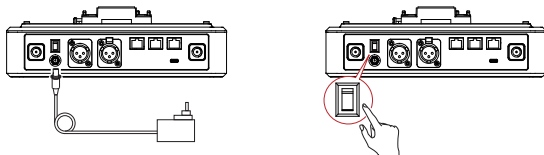

Note: The hub can also be powered on by NP-F batteries, V-mount batteries, or G-mount batteries.

Quick Guide

Pairing

The hub and remote headsets that come from the same system will pair with each other automatically right out of the box. Manual pairing is only required when a new headset needs to be added or when a headset or the hub needs to be replaced.

Connecting a Headset to the Hub Using a USB-C Cable

A USB-C cable is required for pairing. Connect the headset to the hub via the USB interface on the hub and the USB-C interface on the headset. Then, the number selection interface will automatically be displayed on the hub. Simply press the arrow buttons to select a number and press the round Menu/Confirmation button to complete number settings and pairing.

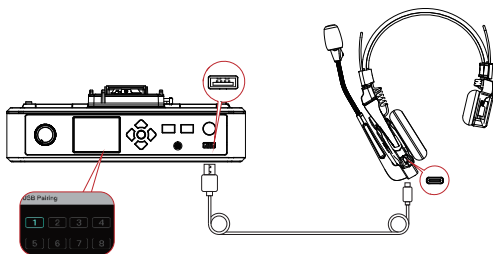

Setting Headset Numbers on the Hub

When repairing and numbering a headset, be sure to turn on all the headsets to avoid selecting duplicate numbers. Otherwise, the other headsets may not be connected.

In case of wrong numbering for the headset, simply connect it to the hub using a USB cable and perform pairing and numbering again.

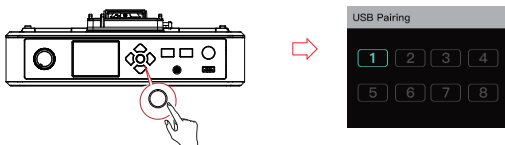



Quick Guide

Configuring the Hub on the Web Server

Turn on the hub, connect it to a computer using a network cable via the RJ45 interface on the hub and the network port on the computer, configure the same network segment for the computer and hub, open a browser on the computer, and then enter the following addresses (Check the corresponding addresses through the network menu on the hub):

Default IP address of a master hub: 192.168.218.10

Default IP address of a remote hub: 192.168.218.11

You can log in to the web server (default password: **12345678**) to upgrade the hub, perform headset grouping, and set headset states.



Parameters

	Hub	Wired Headset
Interface	RJ45 interface Power interface (DC interface) 4-wire audio interface (RJ45 socket) USB interface 2-wire audio interface PGM audio interface USB-C interface OB10 headset interface RF antenna interface	USB-C interface
Antenna	External	Built-in
Power Supply	DC power, NP-F battery, V-mount battery, G-mount battery	700mAh lithium polymer battery
Operation Time	/	About 10 hours
Charging Time	/	About 2.5 hours
Volume Adjustment	Adjustment knob	Adjustable in 7 gears
Power Consumption	<4.5W	<0.3W
Dimensions	(LxWxH): 259.9mmx180.5mmx65.5mm (10.2"x7.1"x2.6")	(LxWxH): 186.9mmx75.6mmx188.6mm (7.4"x3"x7.4")
Net Weight	About 1300g (45.9oz) with the antennas excluded	About 170g (6oz) with the battery included
Transmission Range	1,100ft (350m) LOS	
Frequency Band	1.9 GHz (DECT)	
Wireless Technology	Adaptive Frequency Hopping	
Modulation Mode	GFSK	
Wireless Power	≤ 21dBm (125.9mW)	
Bandwidth	1.728MHz	
RX Sensitivity	<-90dBm	

Frequency Response	150Hz-7kHz
Signal-to-Noise Ratio	>55dB
Distortion	<1%
Input SPL	>115dBSPL
Temperature Range	0°C to 45°C (working condition) -10°C to 60°C (storage condition) Note: The highest working temperature is 40°C when the adapter is used for the power supply.



Safety Precautions

Do not place the product near or inside heating devices (including but not limited to microwave ovens, induction cookers, electric ovens, electric heaters, pressure cookers, water heaters, and gas stoves) to prevent the battery from overheating and exploding.







Do not use non-original charging cases, cables, and batteries with the product. The use of non-original accessories may cause electric shock, fire, explosion, or other dangers.





Support

If you encounter any problems in using the product or need any help, please contact Hollyland Support Team via the following ways:

-  Hollyland User Group
-  HollylandTech
-  HollylandTech
-  HollylandTech
-  support@hollyland.com
-  www.hollyland.com

Statement

All copyrights belong to Shenzhen Hollyland Technology Co., Ltd. Without the written approval of Shenzhen Hollyland Technology Co., Ltd., no organization or individual may copy or reproduce part or all of any written or illustrative content and disseminate it in any form.



Trademark Statement

All the trademarks are owned by Shenzhen Hollyland Technology Co., Ltd.

Note:

Due to product version upgrades or other reasons, this User Manual will be updated from time to time. Unless otherwise agreed, this document is provided as a guide for use only. All representations, information, and recommendations in this document do not constitute warranties of any kind, express, or implied.





FCC Requirement

Any changes or modifications not expressly approved by the party responsible for compliance could void the user's authority to operate the device. This device complies with Part 15 of the FCC Rules.

Operations are subject to the following two conditions:

- (1) This device may not cause harmful interference.
- (2) This device must accept any interference received, including interference that may cause undesired operations.

FCC Radiation Exposure Statement:

The device has been tested and complies with FCC SAR limits.

Note:

This device has been tested and found to comply with the limits for a Class B digital device, pursuant to Part 15 of the FCC Rules. These limits are designed to provide reasonable protection against harmful interference in a residential installation. This device generates, uses, and can radiate radio frequency energy, and if it is not installed and used in accordance with the instructions, it may cause harmful interference to radio communications. However, there is no guarantee that interference will not occur in a particular installation. If this device does cause harmful interference to radio or television reception, which can be determined by turning the device off and on, the user is encouraged to try to correct the interference by one or more of the following measures:

- Reorient or relocate the receiving antenna.
- Increase the distance between the device and the receiver.
- Connect the device to an outlet on a circuit different from that to which the receiver is connected.
- Consult the dealer or an experienced radio/TV technician for help.





Introduction

Nous vous remercions d'avoir acheté le système d'interphone sans fil Solidcom C1 Pro full-duplex à annulation de bruit de Hollyland.

Le Solidcom C1 Pro - Hub4S est un système d'interphone sans fil full-duplex à annulation de bruit conçu pour fournir un son clair et un confort de port tout au long de la journée dans une conception véritablement sans fil, ne nécessitant pas de sac de ceinture. Le système fonctionne sur la bande de 1.9GHz, offrant une portée fiable de 1,100 pieds (350 m).

Ce manuel d'utilisation vous aidera à installer et à utiliser l'équipement.



Contenu de l'emballage

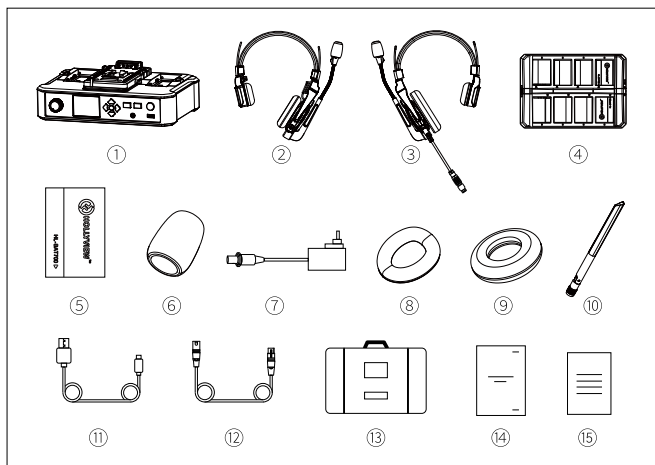

Solidcom C1 Pro - Hub4S Ensemble de casques d'interphone

- | | | |
|---|---|-----|
| ① | Hub | x 1 |
| ② | Casque d'écoute à distance (avec plaque signalétique bleue) | x 4 |
| ③ | 0B10 Casque filaire (avec plaque signalétique rouge) | x 1 |
| ④ | Boîtier de charge à 8 emplacements | x 1 |
| ⑤ | Batterie du casque | x 8 |
| ⑥ | Coussinet pour microphone | x 5 |
| ⑦ | Adaptateur CC 12 V/2 A | x 2 |
| ⑧ | Coussinet en cuir pour casque | x 5 |
| ⑨ | Coussinet en mousse supra-auriculaire | x 5 |
| ⑩ | Antenne à gain élevé | x 4 |
| ⑪ | Câble USB-A vers USB-C | x 1 |
| ⑫ | Câble XLR mâle 3 broches vers XLR femelle 3 broches | x 1 |
| ⑬ | Étui de rangement | x 1 |
| ⑭ | Manuel d'utilisation | x 5 |
| ⑮ | Carte de garantie | x 1 |

Remarque : la quantité d'articles dépend de la configuration du produit.

Guide rapide

Installation des antennes du hub

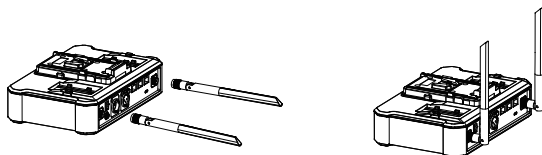

Alimentation du hub

- Connectez l'adaptateur CC 12 V/2 A au hub.
- Mettez le hub en marche.

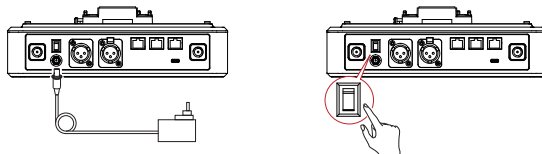

Remarque : Le hub peut également être alimenté par des batteries NP-F, des batteries V-mount ou des batteries G-mount.

Guide rapide

Jumelage

Le hub et les casques d'écoute à distance provenant du même système se jumèleront automatiquement dès leur sortie de l'emballage. Le jumelage manuel n'est nécessaire que lors du jumelage d'un nouveau casque, du remplacement d'un casque ou du hub.

La connexion d'un casque au hub à l'aide d'un câble USB-C

Un câble USB-C est nécessaire pour le jumelage. Connectez le casque au hub à l'aide de l'interface USB du hub et de l'interface USB-C du casque. Ensuite, l'interface de sélection des numéros sera automatiquement affichée sur le hub. Il suffit d'appuyer sur les boutons fléchés pour sélectionner un numéro et d'appuyer sur le bouton rond de Menu/Confirmation pour terminer le paramétrage du numéro et le jumelage.

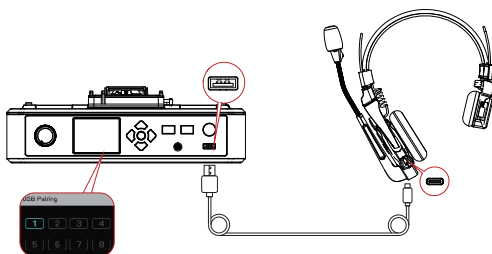

Paramétrage des numéros de casque sur le hub

Lorsque vous réparez et numérotez un casque, veillez à allumer tous les casques afin d'éviter de sélectionner des numéros en double. Autrement, les autres casques risquent de ne pas être connectés.

En cas de numérotation erronée du casque, il suffit de le connecter au hub à l'aide d'un câble USB et de procéder de nouveau au jumelage et à la numérotation.

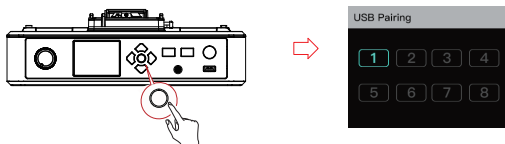



Guide rapide

Paramétrage du hub sur le serveur web

Mettez le hub en marche, connectez-le à un ordinateur en utilisant un câble réseau à l'aide de l'interface RJ45 du hub et du port réseau de l'ordinateur, paramétrez le même segment de réseau pour l'ordinateur et le hub, ouvrez un navigateur sur l'ordinateur, puis entrez les adresses suivantes (vérifiez les adresses correspondantes dans le menu réseau du hub) :

L'adresse IP par défaut d'un hub maître est : 192.168.218.10

L'adresse IP par défaut d'un hub esclave est : 192.168.218.11

Vous pouvez vous connecter au serveur web (mot de passe par défaut) : **12345678** afin de mettre à niveau le hub, effectuer le regroupement des casques et définir les états de ceux-ci



Paramètres

	Hub	Casque filaire
Interface	Interface RJ45 Interface d'alimentation (interface CC) Interface audio à 4 fils (prise RJ45) Interface USB Interface audio à 2 fils Interface audio PGM Interface USB-C Interface pour casque 0B10 Interface d'antenne RF	Interface USB-C
Antenne	Externe	Intégré
Alimentation électrique	Alimentation CC, batterie NP-F, batterie V-mount, batterie G-mount	Batterie lithium-polymère de 700mAh
Autonomie	/	Environ 10 heures
Temps de charge	/	Environ 2,5 heures
Réglage du volume	Molette de réglage	Réglable en 7 vitesses
Consommation électrique	<4,5 W	<0,3 W
Dimensions	(L x L x H) : 259,9 mm x 180,5 mm x 65,5 mm (10,2 po x 7,1 po x 2,6 po)	(L x L x H) : 186,9 mm x 75,6 mm x 188,6 mm (7,4 po x 3 po x 7,4 po)
Poids net	Environ 1300 g (45,9 oz) sans les antennes.	Environ 170 g (6 oz) avec la batterie incluse
Plage de transmission	1,100 pieds (350m) LOS	
Bande de fréquences	1,9 GHz (DECT)	
Technologie sans fil	Saut de fréquence adaptatif	
Mode de modulation	GFSK	

Alimentation sans fil	≤ 21 dBm (125,9 mW)
Bande passante	1,728 MHz
Sensibilité RX	< -90 dBm
Réponse en fréquence	150 Hz-7k Hz
Rapport signal-bruit	> 55 dB
Distorsion	< 1 %
Entrée SPL	> 115 dB SPL
Plage de température	De 0 °C à 45 °C (en état de fonctionnement) De -10 °C à 60 °C (dans des conditions de rangement) Remarque : la température maximale de fonctionnement est de 40°C lorsque l'adaptateur est utilisé pour l'alimentation électrique.









Mesures de sécurité

Ne placez pas le produit à proximité ou à l'intérieur d'appareils chauffants (y compris, mais sans s'y limiter, les fours à micro-ondes, les cuisinières à induction, les fours électriques, les chauffages électriques, les cocottes-minute, les chauffe-eau et les cuisinières à gaz) pour éviter que la batterie ne surchauffe et n'explose. N'utilisez pas de boîtiers de charge, de câbles et de batteries non originaux avec le produit. L'utilisation d'accessoires non originaux peut entraîner des décharges électriques, des incendies, des explosions ou d'autres dangers.



Assistance

Si vous rencontrez des problèmes lors de l'utilisation du produit ou alors que vous avez besoin d'aide, veuillez contacter l'équipe d'assistance de Hollyland par les moyens suivants :

-  Hollyland User Group
-  HollylandTech
-  HollylandTech
-  HollylandTech
-  support@hollyland.com
-  www.hollyland.com

Déclaration

Tous les droits d'auteur appartiennent à Shenzhen Hollyland Technology Co., Ltd. Sans l'accord écrit de Shenzhen Hollyland Technology Co., Ltd, aucune organisation ou personne ne peut copier ou reproduire tout ou partie du contenu écrit ou illustratif et le diffuser sous quelque forme que ce soit.

Déclaration de marque de commerce

Toutes les marques sont la propriété de Shenzhen Hollyland Technology Co., Ltd.

Remarque :

En raison des mises à jour de la version du produit ou d'autres raisons, ce manuel d'utilisation sera mis à jour de temps à autre. Sauf accord contraire, ce document est fourni à titre de guide d'utilisation uniquement. Toutes les représentations, informations, recommandations contenues dans ce document ne constituent pas des garanties de quelque nature que ce soit, explicites ou implicites.



Exigence de la FCC

Tous changements ou modifications non expressément approuvés par la partie responsable de la conformité peut annuler l'autorité de l'utilisateur à faire fonctionner l'appareil. Cet appareil est conforme à la section 15 des règles de la FCC.

Le fonctionnement est assujéti aux deux conditions suivantes :

- (1) Cet appareil ne doit pas causer d'interférences nuisibles.
- (2) Cet appareil doit être compatible avec toutes les interférences reçues, y compris celles susceptibles de provoquer des fonctionnements indésirables.

Déclaration de conformité aux directives de la FCC relatives à l'exposition aux radiations :

L'appareil a été testé et est conforme aux valeurs limites de DAS de la FCC.

Remarque :

Cet appareil a été testé et déclaré conforme aux limites d'un appareil numérique de classe B, conformément à la partie 15 des règles de la FCC. Ces limites sont conçues pour fournir une protection raisonnable contre les interférences nuisibles dans une installation résidentielle. Cet appareil génère, utilise et peut émettre de l'énergie de fréquence radio. S'il n'est pas installé et utilisé conformément aux instructions, il peut provoquer des interférences nuisibles aux communications radio. Cependant, il n'y a aucune garantie que des interférences ne se produiront pas dans une installation particulière. Si cet appareil provoque des interférences nuisibles à la réception de la radio ou de la télévision, ce qui peut être remédié en éteignant et en rallumant celui-ci, l'utilisateur est encouragé à essayer de corriger ces interférences par l'une ou plusieurs des mesures suivantes :

- Réorientez ou déplacez l'antenne réceptrice.
- Augmentez la distance entre l'appareil et le récepteur.
- Connectez l'appareil à une prise sur un circuit différent de celui auquel le récepteur est connecté.
- Consultez le revendeur ou un technicien radio/TV expérimenté pour obtenir de l'aide.





Einführung

Wir freuen uns, dass Sie sich für den Kauf des Solidcom C1 Pro - Hub4S von Hollyland entschieden haben.

Bei dem Solidcom C1 Pro - Hub4S handelt es sich um ein drahtloses Vollduplex-Sprechsystem mit Geräuschunterdrückung, das nicht nur kristallklaren Klang und einen ganztägig hohen Tragekomfort in einer vollständig drahtlosen Ausführung bietet, sondern auch das Tragen einer Gürteltasche überflüssig macht. Das System funktioniert im 1,9-GHz-Band und bietet im offenen Gelände eine zuverlässige Reichweite von bis zu 350 m.

Dieses Benutzerhandbuch hilft Ihnen bei der Einrichtung und Verwendung des Produkts.



Packliste

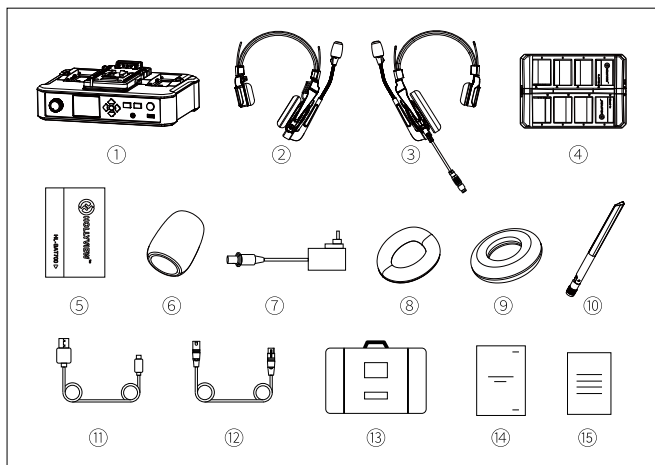

Solidcom C1 Pro - Hub4S (Sprechsystem und Headsets in einem Paket)

①	Hub	x 1
②	Kabelloses Headset (mit blauem Typenschild)	x 4
③	Kabelgebundenes Headset des Typs OB10 (mit rotem Typenschild)	x 1
④	Ladekoffer mit acht Steckplätzen	x 1
⑤	Akku für Headset	x 8
⑥	Überzug für Mikrofon	x 5
⑦	DC-Adapter (12 V/DC, 2 A)	x 2
⑧	Over-Ear-Lederpolster	x 5
⑨	On-Ear-Schaumstoffpolster	x 5
⑩	Antenne mit hoher Verstärkung	x 4
⑪	USB-Kabel mit USB-A- und USB-C-Stecker	x 1
⑫	3-Pin XLR Male auf 3-Pin XLR Female Kabel	x 1
⑬	Aufbewahrungskoffer	x 1
⑭	Benutzerhandbuch	x 5
⑮	Garantiekarte	x 1

Hinweis: Die Stückzahl der Komponenten hängt von der Produktkonfiguration ab.

Kurzanleitung

Montieren der Antennen am Hub

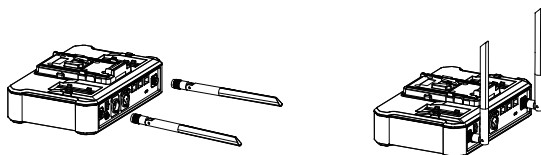

Einschalten des Hubs

- Schließen Sie das DC-Adapter (12 V/DC, 2 A) an den Hub an.

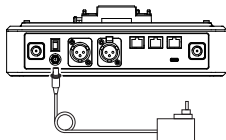

- Schalten Sie den Hub ein.

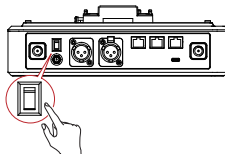

Hinweis: Der Hub kann auch über NP-F-Akkus, V-Mount-Akkus oder G-Mount-Akkus mit Strom versorgt werden.

Kurzanleitung

Einleiten des Kopplungsvorgangs

Der Hub und die kabellosen Headsets, aus denen sich das Sprechsystem zusammensetzt, werden bei Inbetriebnahme automatisch miteinander gekoppelt. Das manuelle Einleiten eines Kopplungsvorgangs ist nur in Fällen erforderlich, in denen ein neues Headset hinzugefügt oder ein Headset oder der Hub ausgetauscht werden muss.

Anschließen eines Headsets an den Hub mithilfe eines USB-C-Kabels

Für das manuelle Koppeln eines Headsets mit dem Hub benötigen Sie ein USB-C-Kabel. Schließen Sie ein Ende des Kabels an die USB-Anschluss am Hub und das andere Ende an die USB-C-Anschluss am Headset an. Im Display des Hubs wird Ihnen daraufhin automatisch die Ansicht für die Auswahl der Kennziffer angezeigt. Verwenden Sie dann eine der Pfeiltasten, um eine Kennziffer auszuwählen, und drücken Sie anschließend die runde Menü-/Bestätigungstaste, um Ihre Auswahl zu bestätigen und den Kopplungsvorgang abzuschließen.

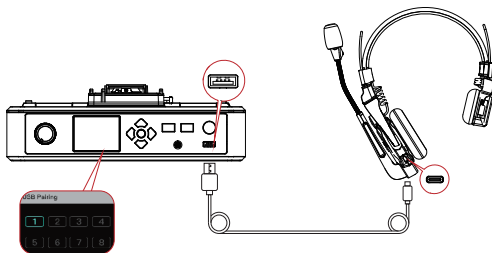

Konfigurieren der Headset-Kennziffern am Hub

Achten Sie bei der erneuten Kopplung eines Headsets und der damit einhergehenden Vergabe einer Kennziffer unbedingt darauf, dass alle Headsets eingeschaltet sind, um der Vergabe doppelter Kennziffern vorzubeugen. Bei Nichtbeachtung dieses Hinweises besteht die Möglichkeit, dass die Kopplung der anderen Headsets fehlschlägt.

Sollte einem Headset die falsche Kennziffer zugeordnet sein, schließen Sie es einfach mithilfe eines USB-Kabels an den Hub an und führen Sie sowohl die Kopplung als auch die Vergabe der Kennziffer erneut durch.

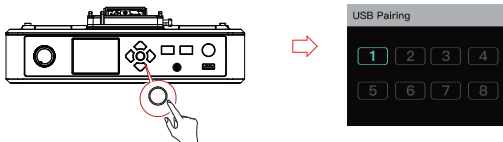

DE-4



Kurzanleitung

Konfigurieren des Hubs auf dem Web-Server

Schalten Sie zunächst einmal den Hub ein und nehmen Sie ein geeignetes Netzwerkkabel zur Hand. Schließen Sie dann ein Ende des Kabels an den RJ45-Anschluss des Hubs und das andere Ende an den Netzwerkanschluss Ihres Computers an. Sorgen Sie dafür, dass sich der Computer und der Hub in ein und demselben Netzwerk befinden, rufen Sie einen Browser auf und geben Sie die nachstehend aufgeführten Adressen ein (die entsprechenden Adressen finden Sie im Netzwerkmenü des Hubs):

Standardmäßige IP-Adresse eines Master-Hubs: 192.168.218.10

Standardmäßige IP-Adresse eines Remote-Hubs: 192.168.218.11

Nachdem Sie sich erfolgreich bei dem Web-Server angemeldet haben (standardmäßiges Passwort: **12345678**), können Sie u. a. die auf dem Hub installierte Firmware-Version aktualisieren, Headsets verschiedenen Gruppen zuordnen und den Status eines Headsets konfigurieren.



Technische Daten

	Hub	Kabelgebundenes Headset
Anschluss	RJ45-Anschluss, Netzeingang (Gleichspannungsanschluss), 4-Draht-Audio-Anschluss (RJ45-Anschluss), USB-Anschluss 2-Draht-Audio-Anschluss PGM-Anschluss USB-C-Anschluss 0B10-Headset-Anschluss HF-Antennenanschluss	USB-C-Anschluss
Antenne	extern	integriert
Stromversorgung	Gleichspannungsnetzteil, NP-F-Akku, V-Mount-Akku, G-Mount-Akku	Lithium-Polymer-Akku (700 mAh)
Betriebszeit	/	etwa 10 Stunden
Ladedauer	/	etwa 2,5 Stunden
Lautstärkeregelung	Lautstärkereglер	7 einstellbare Pegel
Leistungsaufnahme	<4,5 W	<0,3 W
Abmessungen	(L x B x H): 259,9 x 180,5 x 65,5 mm (10,2" x 7,1" x 2,6")	(L x B x H): 186,9 x 75,6 x 188,6 mm (7,4" x 3" x 7,4")
Nettogewicht	etwa 1300 g (45,9 oz) ohne Antennen	etwa 170 g (6 oz) mit eingesetztem Akku
Übertragungsreichweite	350 m in offenem Gelände	
Frequenzband:	1,9 GHz (DECT)	
Funktechnik	Adaptives Frequenzsprungverfahren	
Modulationsart	GFSK	
Funksendeleistung	≤ 21 dBm (125,9 mW)	
Bandbreite	1,728 MHz	

Eingangsempfindlichkeit	<-90 dBm
Frequenzgang	150 Hz - 7 kHz
Signal-Rausch-Verhältnis	>55 dB
Verzerrung	<1 %
Eingangsschalldruckpegel	>115 dBSPL
Temperaturbereich	0 bis +45 °C (Betriebstemperatur) -10 bis +60 °C (Lagertemperatur) Hinweis: Bei Verwendung des Netzteils ist darauf zu achten, dass die Betriebstemperatur einen Wert von +40 °C nicht überschreitet.



Sicherheitsvorkehrungen

Stellen Sie das Produkt weder in der Nähe noch im Inneren eines Heizgeräts (u. a. Mikrowellenherde, Induktionsherde, Elektroherde, elektrische Heizgeräte, Schnellkochtöpfe, Durchlauferhitzer, Gasherde) auf, um einer Überhitzung und einer möglichen Explosion der integrierten Akkus vorzubeugen.







Sehen Sie dringend davon ab, das Produkt gemeinsam mit nicht originalen Ladekoffern, Kabeln und Akkus zu verwenden. Die Nichtbeachtung dieses Hinweises kann einen elektrischen Schlag, die Entstehung eines Brands, Explosionen und weitere Gefahren nach sich ziehen.





Kundenbetreuung

Sollten Sie Probleme bei der Verwendung des Produkts haben oder anderweitig Hilfe benötigen, wenden Sie sich bitte über einen der nachstehend aufgeführten Wege an den Kundendienst von Hollyland:

-  Hollyland User Group
-  HollylandTech
-  HollylandTech
-  HollylandTech
-  support@hollyland.com
-  www.hollyland.com

Urheberrechtserklärung

Sämtliche der Urheberrechte liegen bei Shenzhen Hollyland Technology Co., Ltd. Weder Unternehmen noch Einzelpersonen dürfen ohne die vorherige schriftliche Genehmigung von Shenzhen Hollyland Technology Co., Ltd. die schriftlichen oder illustrativen Inhalte dieses Benutzerhandbuchs kopieren, vervielfältigen oder in irgendeiner Form verbreiten.

Erklärung zu den Warenzeichen

Sämtliche der hierin enthaltenen Warenzeichen sind Eigentum von Shenzhen Hollyland Technology Co, Ltd.

Hinweis:

Dieses Benutzerhandbuch wird u. a. aufgrund von Aktualisierungen der auf dem Produkt installierten Firmware-Version regelmäßig überarbeitet. Sofern nicht anders vereinbart, wird dieses Dokument nur als Anleitung zur Verwendung bereitgestellt. Alle Aussagen, Informationen und Empfehlungen in diesem Dokument stellen keine ausdrücklichen oder stillschweigenden Garantien dar.





FCC-Konformität

Jegliche Änderungen oder Modifikationen, die nicht ausdrücklich von der für die Konformität verantwortlichen Partei genehmigt wurden, können zum Erlöschen der Betriebsberechtigung des Geräts durch den Benutzer führen. Dieses Gerät erfüllt die in Abschnitt 15 der FCC-Vorschriften aufgeführten Anforderungen.

Der Betrieb unterliegt den beiden folgenden Bedingungen:

- (1) Dieses Gerät darf keine den Funkverkehr gefährdenden Interferenzen verursachen.
- (2) Dieses Gerät muss alle empfangenen Interferenzen – und zwar einschließlich solcher, die zu einem unerwünschten Betrieb führen könnten – akzeptieren.

FCC-Erklärung zur Strahlenbelastung:

Das Gerät wurde getestet und entspricht den SAR-Grenzwerten der FCC.

Hinweis:

Dieses Gerät wurde getestet und entspricht gemäß Abschnitt 15 der FCC-Bestimmungen den Grenzwerten für digitale Geräte der Klasse B. Diese Grenzwerte sind dazu bestimmt, einen angemessenen Schutz vor funktechnischen Interferenzen in Wohngebieten zu gewährleisten. Dieses Gerät erzeugt und verwendet Hochfrequenzenergie und kann diese abstrahlen. Sollte es nicht gemäß den Anweisungen eingerichtet und verwendet werden, kann es schädliche Störungen des Funkverkehrs verursachen. Es kann jedoch nicht garantiert werden, dass bei einer bestimmten Konfiguration keine Störungen auftreten. Sollte dieses Gerät den Radio- oder Fernsehempfang stören, was sich leicht durch Aus- und Einschalten des Geräts überprüfen lässt, wird dem Benutzer nahegelegt, die funktechnischen Störungen durch eine der nachstehend aufgeführten Maßnahmen zu beheben:

- Verändern Sie die Ausrichtung oder den Standort der Empfangsantenne.
- Vergrößern Sie den Abstand zwischen dem Gerät und dem Empfänger.
- Schließen Sie das Gerät an eine Steckdose an, die nicht mit dem Stromkreis des Empfängers verbunden ist.
- Holen Sie sich Rat bei Ihrem Fachhändler oder einem erfahrenen Radio-/ Fernsehtechniker.





Introduzione

Grazie per aver acquistato il sistema di intercomunicazione wireless full-duplex con soppressione dei disturbi Hollyland Solidcom C1 Pro.

Solidcom C1 Pro - Hub4S è un sistema di intercomunicazione wireless full-duplex con soppressione dei disturbi progettato per un audio chiaro e per offrire il massimo comfort tutto il giorno, con un design realmente wireless che non richiede un marsupio. Il sistema funziona nella banda degli 1.9 GHz, con una portata in campo aperto fino a 350 m in trasmissione e ricezione.

Il presente manuale dell'utente sarà utile per l'installazione e l'utilizzo del prodotto.



Contenuto della confezione

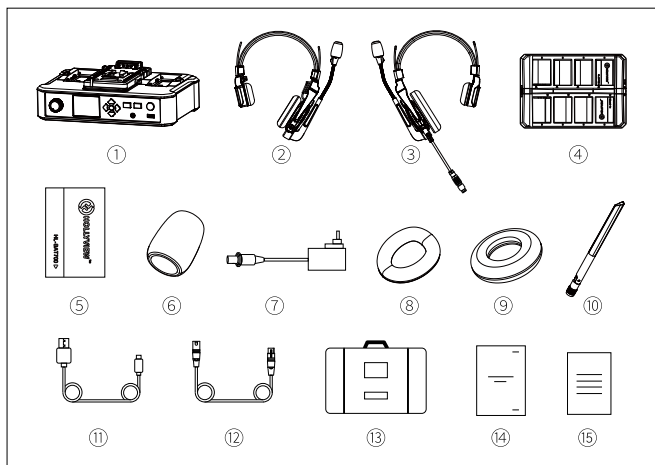

Solidcom C1 Pro - Hub4S: pacchetto di intercomunicazione con cuffie

①	Centralina	x 1
②	Cuffie remote (con targhetta blu)	x 4
③	Cuffie cablate 0B10 (con targhetta rossa)	x 1
④	Custodia per la ricarica a 8 slot	x 1
⑤	Batteria delle cuffie	x 8
⑥	Imbottitura del microfono	x 5
⑦	Alimentatore 12 VCC, 2 A	x 2
⑧	Imbottitura over-ear in pelle	x 5
⑨	Imbottitura on-ear in schiuma	x 5
⑩	Antenna ad alto guadagno	x 4
⑪	Cavo da USB-A a USB-C	x 1
⑫	Cavo XLR maschio a 3 pin a XLR femmina a 3 pin	x 1
⑬	Custodia	x 1
⑭	Manuale dell'utente	x 5
⑮	Certificato di garanzia	x 1

Nota: il numero di elementi dipende dalla configurazione del prodotto.

Guida introduttiva rapida

Installazione delle antenne della centralina

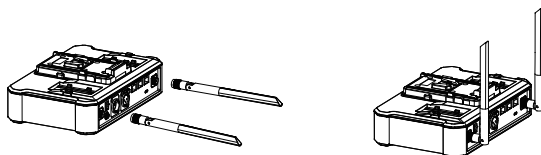

Accensione della centralina

- Collegare alla centralina l'alimentatore da 12 VCC, 2 A.
- Avviare la centralina.

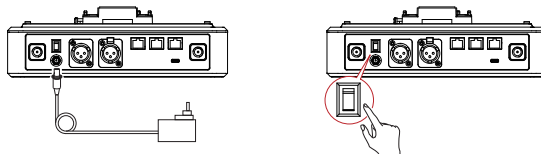

Nota: la centralina può anche essere alimentata con batterie NP-F, batterie V-Mount o batterie G-Mount.

Guida introduttiva rapida

Abbinamento

Se la centralina e le cuffie remote appartengono allo stesso sistema si abbineranno automaticamente tra loro senza necessità di configurazione. L'abbinamento manuale è necessario solo se è necessario aggiungere una nuova cuffia o sostituire una cuffia o la centralina.

Collegamento di una cuffia alla centralina tramite un cavo USB-C

Per l'abbinamento è necessario un cavo USB-C. Collegare le cuffie alla centralina tramite l'interfaccia USB sulla centralina e l'interfaccia USB-C sulle cuffie. L'interfaccia per la selezione del numero verrà visualizzata automaticamente sulla centralina. Premere i pulsanti freccia per selezionare un numero e premere il pulsante tondo Menu/Conferma per confermare le impostazioni dei numeri e l'abbinamento.

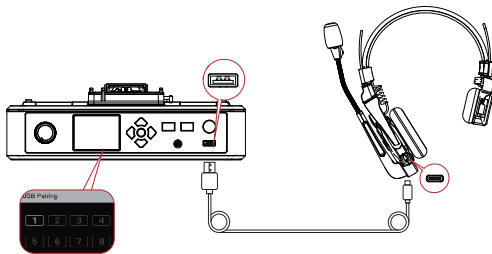

Definizione dei numeri delle cuffie sulla centralina

Quando si riparano e si numerano le cuffie, occorre accenderle tutte per evitare di selezionare numeri duplicati. In caso contrario, il collegamento delle altre cuffie potrebbe non riuscire.

Se la numerazione delle cuffie è errata basterà collegarle alla centralina con un cavo USB ed eseguire nuovamente l'abbinamento e la numerazione.

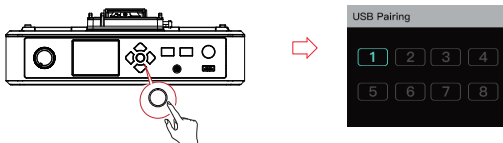



Guida introduttiva rapida

Configurazione della centralina sul server web

Accendere la centralina, collegarla a un computer con un cavo di rete tramite l'interfaccia RJ45 sulla centralina e la porta di rete sul computer, configurare lo stesso segmento di rete per il computer e per la centralina, aprire un browser sul computer, quindi inserire i seguenti indirizzi (controllare gli indirizzi corrispondenti tramite il menu della rete sulla centralina):

Indirizzo IP predefinito centralina master: 192.168.218.10

Indirizzo IP predefinito centralina remota: 192.168.218.11

È possibile accedere al server web (password predefinita: **12345678**) per aggiornare la centralina, gestire i gruppi delle cuffie e impostare gli stati delle cuffie.



Parametri

	Centralina	Cuffie cablate
Interfaccia	Interfaccia RJ45 Interfaccia di alimentazione (interfaccia CC) Interfaccia audio a 4 fili (presa RJ45) Interfaccia USB Interfaccia audio a 2 fili Interfaccia audio PGM Interfaccia USB-C Interfaccia cuffie OB10 Interfaccia antenna RF	Interfaccia USB-C
Antenna	Esterna	Integrata
Alimentazione	Alimentazione CC, batteria NP-F, batteria V-Mount, batteria G-Mount	Batteria ai polimeri di litio da 700 mAh
Autonomia	/	Circa 10 ore
Tempo di ricarica	/	Circa 2,5 ore
Regolazione del volume	Ghiera di regolazione	Regolabile in 7 livelli
Assorbimento	4,5 W	0,3 W
Dimensioni	(LxPxA): 259,9 mm x 180,5 mm x 65,5 mm (10,2" x 7,1" x 2,6")	(LxPxA): 186,9 mm x 75,6 mm x 188,6 mm (7,4" x 3" x 7,4")
Peso netto	Circa 1.300 g antenne escluse	Circa 170 g batteria inclusa
Portata di trasmissione	LOS 350 m	
Banda di frequenza	1,9 GHz (DECT)	
Tecnologia wireless	Hopping di frequenza adattivo	
Modalità di modulazione	GFSK	
Segnale wireless	≤ 21dBm (125,9 mW)	

Larghezza di banda	1,728 MHz
Sensibilità RX	<-90dBm
Risposta in frequenza	150 Hz-7 kHz
Rapporto segnale/ rumore	>55 dB
Distorsione	<1%
SPL in ingresso	>115 dB SPL
Intervallo di temperatura	Da 0 °C a 45 °C (condizioni operative) Da -10 °C a 60 °C (condizioni di stoccaggio) Nota: la temperatura operativa massima è 40 °C, quando si usa l'alimentatore.



Precauzioni di sicurezza







Non posizionare il prodotto vicino o all'interno di dispositivi che emettono calore (come forni a microonde, cucine a induzione, forni elettrici, stufette elettriche, pentole a pressione, scaldabagni, stufe a gas) per evitare che la batteria si surriscaldi ed esploda.

Non utilizzare con il prodotto custodie di ricarica, cavi e batterie non originali. L'uso di accessori non originali può causare scariche elettriche, incendi, esplosioni o altri pericoli.



Assistenza

Se si riscontrano problemi nell'utilizzo del prodotto o per ricevere assistenza, contattare il team di assistenza Hollyland nei modi seguenti:

-  Hollyland User Group
-  HollylandTech
-  HollylandTech
-  HollylandTech
-  support@hollyland.com
-  www.hollyland.com

Dichiarazione

Tutti i diritti d'autore appartengono a Shenzhen Hollyland Technology Co., Ltd. Senza l'approvazione scritta di Shenzhen Hollyland Technology Co., Ltd., nessuna organizzazione o persona può copiare o riprodurre il testo o le immagini, né parzialmente né interamente, o diffonderli in qualsiasi modo.

Dichiarazione sul marchio

Tutti i marchi appartengono a Shenzhen Hollyland Technology Co., Ltd.

Nota:

A seguito di aggiornamenti del prodotto o per altri motivi, il presente manuale dell'utente verrà occasionalmente aggiornato. Se non diversamente concordato, il presente documento viene fornito solo come guida all'uso del prodotto. Tutte le dichiarazioni, le informazioni e le raccomandazioni contenute nel presente documento non costituiscono garanzie di alcun tipo, né espresse o implicite.



REQUISITI FCC

Eventuali modifiche o cambiamenti non espressamente approvati dal responsabile della conformità potrebbero invalidare il diritto dell'utente a utilizzare il dispositivo.

Questo dispositivo è conforme alla Sezione 15 delle norme FCC.

L'utilizzo è soggetto alle due condizioni seguenti:

- (1) Il dispositivo non deve causare interferenze dannose.
- (2) Il dispositivo deve accettare qualsiasi interferenza ricevuta, comprese quelle che potrebbero comprometterne il funzionamento.

Dichiarazione FCC sull'esposizione alle radiazioni:

Il dispositivo è stato testato ed è conforme ai limiti SAR della FCC.

Nota:

Questo dispositivo è stato collaudato ed è risultato conforme ai limiti stabiliti per i dispositivi digitali di classe B, ai sensi della Parte 15 delle norme FCC. Questi limiti sono destinati a fornire una protezione ragionevole contro le interferenze dannose in ambiente residenziale. Questo dispositivo genera, utilizza e può irradiare energia a radiofrequenza e se non è installato e utilizzato secondo le istruzioni può causare interferenze dannose alle comunicazioni radio. Tuttavia non è possibile garantire che non si verifichino interferenze in un'installazione specifica. Se il dispositivo dovesse causare interferenze dannose alla ricezione radiofonica o televisiva (per verificarlo è possibile spegnere e riaccendere il dispositivo), si può cercare di eliminarle nei modi seguenti:

- Orientare o posizionare diversamente l'antenna ricevente.
- Allontanare tra il dispositivo dal ricevitore.
- Collegare il dispositivo a una presa appartenente a un circuito diverso da quello a cui è collegato il ricevitore.
- Consultare il rivenditore o un tecnico radio/TV qualificato.





Introducción

Gracias por comprar el sistema de intercomunicación inalámbrica dúplex completo con cancelación de ruido Solidcom C1 Pro de Hollyland.

El Solidcom C1 Pro - Hub4S es un sistema de intercomunicación inalámbrica dúplex completo diseñado para proporcionar un audio claro y comodidad al llevarlo todo el día en un diseño verdaderamente inalámbrico sin necesidad de una pila. El sistema funciona en la banda de 1,9 GHz, y ofrece un rango de transmisión fiable hasta 350 m de radio (campo visual).

Este manual de usuario le ayudará durante la instalación y el uso del equipo.



Contenido del paquete

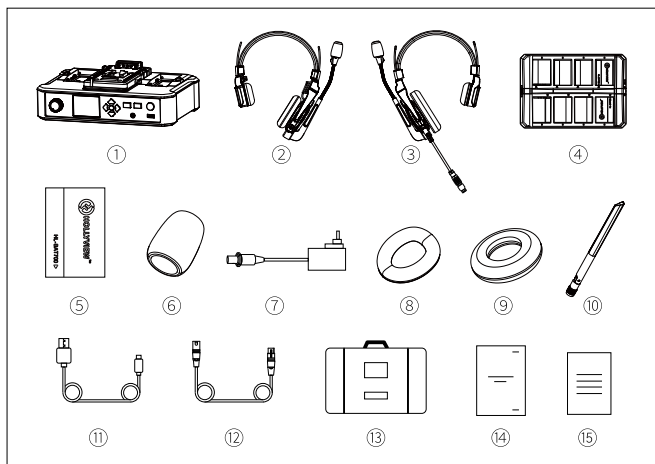

Paquete del auricular de intercomunicación Solidcom C1 Pro - Hub4S

①	Hub	x 1
②	Auriculares remotos (con placa de identificación azul)	x 4
③	Auricular con cable 0B10 (con placa de identificación roja)	x 1
④	Estuche de carga de 8 ranuras	x 1
⑤	Batería de los auriculares	x 8
⑥	Almohadilla del micrófono	x 5
⑦	Adaptador de CC de 12 V / 2 A	x 2
⑧	Almohadilla de cuero circumaural	x 5
⑨	Almohadilla de espuma supraaural	x 5
⑩	Antena de alta ganancia	x 4
⑪	Cable USB-A a USB-C	x 1
⑫	Cable XLR macho de 3 pines a XLR hembra de 3 pines	x 1
⑬	Estuche de almacenamiento	x 1
⑭	Manual de usuario	x 5
⑮	Tarjeta de garantía	x 1

Nota: La cantidad de artículos depende de la configuración del producto.

Guía rápida

Instalación de las antenas del hub

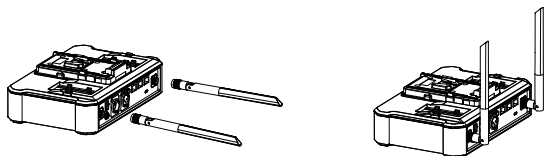

Alimentación del hub

- Conecte el adaptador de CC de 12 V / 2 A al hub.
- Encienda el hub.

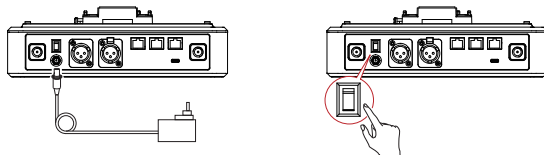

Nota: El hub también se puede alimentar con baterías NP-F, V-mount o G-mount.

Guía rápida

Emparejamiento

El hub y los altavoces remotos del mismo sistema se emparejarán entre ellos automáticamente al sacarlos de la caja. El emparejamiento manual solo es necesario cuando se tiene que añadir un nuevo auricular o cuando se tiene que reemplazar un auricular o el hub.

Conexión de un auricular al hub usando un cable USB-C

Se necesita un cable USB-C para el emparejamiento. Conecte el auricular al hub mediante la interfaz del hub y la interfaz USB-C del auricular. Entonces se mostrará la interfaz de selección de número automáticamente en el hub. Basta con presionar los botones de flecha para seleccionar un número y el botón de menú/confirmación para completar el ajuste del número y el emparejamiento.

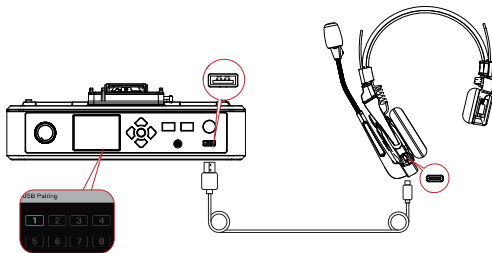

Ajuste de los números de los auriculares en el hub

Cuando repare y numere un auricular, asegúrese de encender todos los auriculares para evitar seleccionar números duplicados. De lo contrario, los demás auriculares podrían no conectarse.

En el caso de que numere mal el auricular, basta con conectarlo al hub con un cable USB y realizar el emparejamiento y la numeración de nuevo.

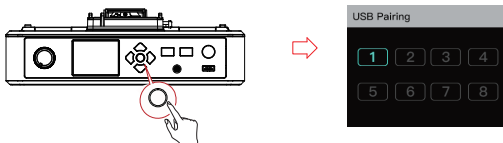



Guía rápida

Configuración del hub en el servidor web

Encienda el hub, conéctelo a un ordenador con un cable de red mediante la interfaz RJ45 del hub y el puerto de red del ordenador; configure el mismo segmento de red para el ordenador y el hub, abra un navegador en el ordenador y acceda a las siguientes direcciones (compruebe las direcciones correspondientes a través del menú de red en el hub):

Dirección IP predeterminada de un hub principal: 192.168.218.10

Dirección IP predeterminada de un hub remoto: 192.168.218.11

Puede iniciar sesión en el servidor web (contraseña predeterminada: **12345678**) para actualizar el hub, agrupar los auriculares y establecer los estados de los auriculares.



Parámetros

	Hub	Auricular con cable
Interfaz	Interfaz RJ45 Interfaz de alimentación (interfaz de CC) Interfaz de audio de 4 hilos (toma RJ45) Interfaz USB Interfaz de audio de 2 hilos Interfaz de audio PGM Interfaz USB-C Interfaz de los auriculares 0B10 Interfaz de la antena de radiofrecuencia	Interfaz USB-C
Antena	Externa	Integrada
Fuente de alimentación	Alimentación con CC, batería NP-FN, batería V-mount, batería G-mount	Batería de polímero de litio de 700 mAh
Tiempo de funcionamiento	/	Unas 10 horas
Tiempo de carga	/	Unas 2,5 horas
Ajuste de volumen	Perilla de ajuste	Ajustable en 7 niveles
Consumo de energía	<4,5 W	<0,3 W
Dimensiones	(L x An x Al): 259,9 mm x 180,5 mm x 65,5 mm (10,2" x 7,1" x 2,6")	(L x An x Al): 186,9 mm x 75,6 mm x 188,6 mm (7,4" x 3" x 7,4")
Peso neto	Unos 1300 g (45,9 oz) sin las antenas	Unos 170 g (6 oz) con las baterías
Alcance de transmisión	Línea de visión de 350 m	
Banda de frecuencia	1,9 GHz (DECT)	

Tecnología inalámbrica	Salto de frecuencia adaptativo
Modo de modulación	GFSK
Potencia inalámbrica	≤ 21 dBm (125,9 mW)
Ancho de banda	1728 MHz
Sensibilidad de RX	< -90 dBm
Frecuencia de respuesta	150 Hz ~ 7 kHz
Relación señal-ruido	> 55 dB
Distorsión	< 1 %
Presión sonora de entrada	> 115 dB SPL
Rango de temperaturas	De 0 °C a 45 °C (en funcionamiento) De -10 °C a 60 °C (guardado) Nota: La temperatura de funcionamiento más alta es de 40 °C cuando el adaptador se usa para la fuente de alimentación.



Medidas de seguridad

No coloque el producto cerca o dentro de dispositivos que produzcan calor (incluyendo, entre otros, microondas, cocinas de inducción, hornos eléctricos, calentadores eléctricos, ollas de presión, calentadores de agua y estufas de gas) para evitar que la batería se sobrecaliente y explote.







Use solo estuches de carga, cables y baterías originales con el producto. El uso de accesorios no originales puede causar descargas eléctricas, fuego, explosiones u otros peligros.





Asistencia técnica

Si encuentra algún problema al usar el producto u necesita ayuda, póngase en contacto con el equipo de asistencia técnica de Hollyland de las siguientes formas:

-  Hollyland User Group
-  HollylandTech
-  HollylandTech
-  HollylandTech
-  support@hollyland.com
-  www.hollyland.com

Advertencia

Todos los derechos pertenecen a Shenzhen Hollyland Technology Co., Ltd. Sin la aprobación por escrito de Shenzhen Hollyland Technology Co., Ltd., ninguna organización o individuo puede copiar o reproducir parte o la totalidad del contenido del texto sin autorización y no puede difundirlo de ninguna forma.

Declaración de la marca registrada

Todas las marcas comerciales pertenecen a Shenzhen Hollyland Technology Co., Ltd.

Nota:

Debido a las actualizaciones de la versión del producto o a otras razones, esta guía rápida se actualizará de vez en cuando. A menos que se acuerde lo contrario, este documento se proporciona como una guía para su uso. Todas las declaraciones, informaciones y recomendaciones contenidas en este documento no constituyen garantías de ningún tipo, expresas o implícitas.





Requisitos de la FCC

Cualquier cambio o modificación no aprobado expresamente por la parte responsable del cumplimiento podría anular la autorización del usuario para utilizar el dispositivo. Este dispositivo cumple con el apartado 15 de las normas de la FCC.

Su funcionamiento está sujeto a las siguientes dos condiciones:

- (1) Este dispositivo no puede causar interferencias perjudiciales.
- (2) Este dispositivo debe aceptar cualquier interferencia recibida, incluidas aquellas que puedan causar un funcionamiento indeseado.

Declaración de exposición a la radiación de la FCC:

El dispositivo se ha probado y cumple con los límites de SAR de la FCC.

Nota:

Este dispositivo ha sido comprobado y cumple con los límites para un servicio digital de clase B según el apartado 15 de las normas de la FCC. Estos límites han sido diseñados para brindar una protección razonable contra interferencias nocivas dentro de una instalación doméstica. El dispositivo genera, usa y puede radiar energía de radiofrecuencia, y podría causar interferencias perjudiciales a las comunicaciones de radio si no se instala y usa según las instrucciones. Sin embargo, no se garantiza que no existan interferencias en una instalación en particular. Si este dispositivo causara interferencias perjudiciales a la recepción de radio o televisión, lo que se puede comprobar al apagarlo y encenderlo, se recomienda que intente corregirlas siguiendo una o más de las siguientes medidas:

- Reoriente o cambie de ubicación la antena de recepción.
- Aumente la distancia entre el dispositivo y el receptor.
- Conecte el dispositivo a un enchufe o circuito diferente del circuito al que está conectado el receptor.
- Consulte con el distribuidor o un técnico especializado en radio/TV si necesita ayuda.





Introdução

Agradecemos sua compra do sistema de intercomunicação sem fio full-duplex com cancelamento de ruído Hollyland Solidcom C1 Pro.

O Solidcom C1 Pro - Hub4S é um sistema de intercomunicação sem fio full-duplex com cancelamento de ruído projetado para fornecer áudio nítido e conforto para uso o dia inteiro com um design realmente sem fio, sem necessidade de cinto belt-pack. O sistema opera na faixa de 1,9Ghz, oferecendo uma faixa LOS confiável de até 1.100ft (350m).

Este Manual do Usuário oferece orientações passo a passo para a instalação e uso do equipamento.



Conteúdo da embalagem

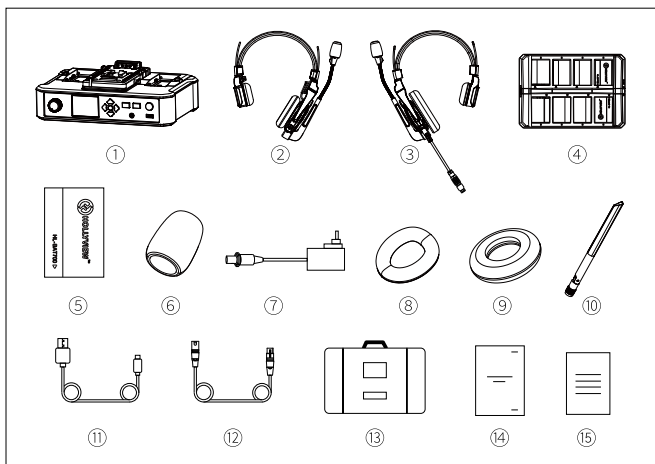

Solidcom C1 Pro - Pacote de headset para intercomunicação Hub4S

①	Hub	x 1
②	Headset remoto (com placa de identificação azul)	x 4
③	Headset c/fio 0B10 (c/placa de identificação vermelha)	x 1
④	Estojo carregamento 8 slots	x 1
⑤	Bateria do headset	x 8
⑥	Almofada para microfone	x 5
⑦	Adaptador CC 12V/2A	x 2
⑧	Almofada couro supra-aural	x 5
⑨	Almofada espuma p/orelha	x 5
⑩	Antena alto ganho	x 4
⑪	Cabo USB-A p/USB-C	x 1
⑫	Cabo XLR macho de 3 pinos para cabo XLR fêmea de 3 pinos	x 1
⑬	Estojo armazenamento	x 1
⑭	Manual do usuário	x 5
⑮	Cartão de garantia	x 1

Nota: A quantidade de itens depende da configuração do produto.

Guia rápido

Instalação das antenas do hub

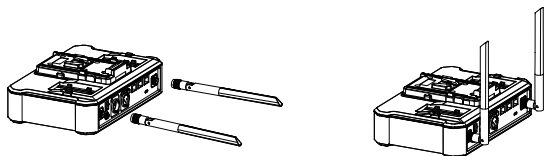

Como ligar o hub

- Conecte o adaptador CC 12V/2A ao hub.

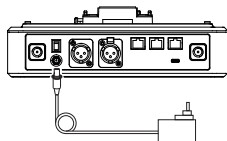

- Ligue o hub.

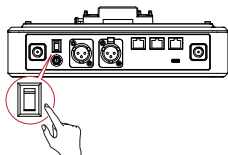

Nota: O hub também pode ser alimentado por baterias NP-F, baterias V-mount ou baterias G-mount.

Guia rápido

Pareamento

O hub e os headsets remotos que vêm do mesmo sistema serão emparelhados automaticamente uns com os outros assim que forem retirados da caixa. O emparelhamento manual só é necessário quando um novo headset precisa ser adicionado ou quando um headset ou o hub precisa ser substituído.

Como conectar um headset ao hub usando um cabo USB-C

O emparelhamento requer um cabo USB-C. Conecte o headset ao hub por meio da interface USB do hub e da interface USB-C no headset. Então, a interface de seleção de número será exibida automaticamente no hub. Basta pressionar os botões de seta para selecionar um número e pressionar o botão redondo de Menu/Confirmação para concluir as configurações de número e emparelhamento.

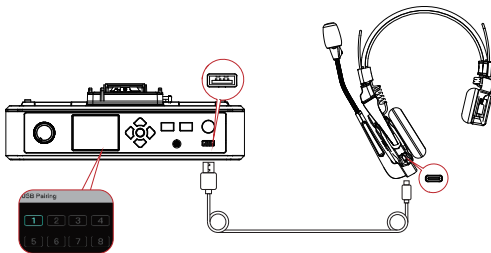

Como configurar números do headset no hub

Ao reparar e numerar um headset, certifique-se de ligar todos os headsets, para evitar a seleção de números duplicados. Caso contrário, os outros headsets talvez não sejam conectados.

Caso erre a numeração do headset, basta conectá-lo ao hub usando o cabo USB e realizar o emparelhamento e numeração novamente.

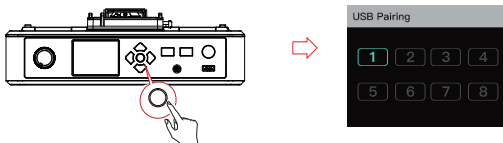



Guia rápido

Como configurar o hub no servidor

Ligue o hub, conecte-o a um computador com um cabo de rede por meio da interface RJ45 no hub e a porta de rede no computador, configure o mesmo segmento de rede para o computador e hub, abra um navegador no computador e digite os seguintes endereços (confira os endereços correspondentes através do menu de rede no hub):

Endereço IP padrão de um hub principal: 192.168.218.10

Endereço IP padrão de um hub remoto: 192.168.218.11

Você pode fazer login no servidor web (senha padrão: **12345678**) para atualizar o hub, realizar o agrupamento de headsets e definir estados do headset.



Parâmetros

	Hub	Headset com fio
Interface	Interface RJ45 Interface de alimentação (interface CC) Interface áudio 4 fios (soquete RJ45) Interface USB Interface áudio 2 fios Interface áudio PGM Interface USB-C Interface do headset 0B10 Interface antena RF	Interface USB-C
Antena	Externa	Integrada
Alimentação	Alimentação CC, Bateria NP, Bateria V-mount, Bateria G-mount	Bateria polímero lítio 700mAh
Tempo de operação	/	Aprox. 10 horas
Tempo de carregamento	/	Cerca de 2,5 horas
Ajuste volume	Botão de ajuste	Ajustável em 7 equipamentos
Consumo de energia	<4,5W	<0,3W
Dimensões	(CxLxA): 259,9mmx180,5mmx65,5mm (10,2"x7,1"x2,6")	(CxLxA): 186,9mmx75,6mmx188,6mm (7,4"x3"x7,4")
Peso líquido	Aprox. 1300g (45,9oz) excluindo antenas	Aprox.170g (6oz) com bateria incluída
Alcance da transmissão	1.100ft (350m) LOS	
Faixa de frequência	1,9 GHz (DECT)	
Tecnologia sem fio	Salto de frequência adaptável	
Modo de modulação	GFSK	
Potência sem fio	≤ 21 dBm (125,9mW)	

Largura de banda	1,728MHz
Sensibilidade de recepção	<-90dBm
Resposta de frequência	150Hz-7kHz
Relação sinal/ruído	>55dB
Distorção	<1%
SPL de entrada	>115dBSPL
Faixa de temperatura	0°C a 45°C (em operação) -10°C a 60°C (em armazenamento) Nota: A temperatura operacional máxima é de 40°C quando o adaptador é usado para a fonte de alimentação.



Precauções de segurança







Não coloque o produto próximo ou dentro de aparelhos que emitam calor (incluindo, entre outros, fornos micro-ondas, fogões por indução, fornos elétricos, aquecedores elétricos, painéis de pressão, aquecedores de água e fogões a gás) para evitar que a bateria superaqueça e exploda.

Não use estojos de recarga, cabos e baterias que não sejam originais no produto. O uso de acessórios não originais pode causar choque elétrico, incêndio, explosão ou outros perigos.



Suporte

Se tiver problemas ao usar o produto ou precisar de ajuda, entre em contato com a Equipe de Suporte da Hollyland das seguintes maneiras:

-  Hollyland User Group
-  HollylandTech
-  HollylandTech
-  HollylandTech
-  support@hollyland.com
-  www.hollyland.com

Declaração

Todos os direitos autorais pertencem a Shenzhen Hollyland Technology Co., Ltd. Nenhuma organização ou indivíduo está autorizado a copiar ou reproduzir, parcial ou integralmente, qualquer conteúdo escrito ou ilustrativo ou a disseminá-lo em qualquer forma ou maneira sem a aprovação por escrito da Shenzhen Hollyland Technology Co., Ltd.

Declaração de marca registrada

Todas as marcas registradas são de propriedade de Shenzhen Hollyland Technology Co., Ltd.

Nota:

Devido a atualizações de versões do produto ou por outras razões, o Manual do Usuário será atualizado periodicamente. A menos que de outro modo acordado, este documento é fornecido apenas como um guia para uso. Nenhuma representação, informação e recomendação contida neste documento constitui garantia de qualquer espécie, expressa ou implícita.



Requisito da FCC

Qualquer alteração ou modificação não aprovada expressamente pela parte responsável pela conformidade pode anular a autoridade do usuário de operar o dispositivo. Este dispositivo está em conformidade com a Parte 15 das normas da FCC.

As operações estão sujeitas às duas condições seguintes:

- (1) Este dispositivo não pode causar interferências prejudiciais.
- (2) Este dispositivo deve aceitar qualquer interferência recebida, incluindo as que possam causar funcionamentos indesejáveis.

Declaração de exposição à radiação da FCC:

O dispositivo foi testado e está em conformidade com os limites de SAR da FCC.

Nota:

Este dispositivo foi testado e considerado em conformidade com os limites para um dispositivo digital da classe B, de acordo com a Parte 15 das normas da FCC. Esses limites foram elaborados para fornecer uma proteção razoável contra interferências prejudiciais em um ambiente residencial. Este dispositivo gera, utiliza e pode irradiar energia de radiofrequência e, caso não seja instalado e usado de acordo com as instruções, pode provocar interferências nocivas para comunicações via rádio. No entanto, não há garantias de que a interferência não ocorrerá em instalações específicas. Se este dispositivo causar interferências prejudiciais à recepção de rádio ou televisão, o que se pode verificar desligando e ligando o dispositivo, recomenda-se tentar corrigir as interferências utilizando uma ou mais das medidas abaixo:

- Reorientar ou mudar a posição da antena de recepção.
- Aumentar a distância entre o dispositivo e o receptor.
- Ligar o dispositivo em uma tomada que tenha um circuito diferente da tomada onde está ligado o receptor.
- Consultar o revendedor ou pedir ajuda a um profissional técnico de rádio ou televisão.





